

LINEA **UFFICIO**
BIC
2026



PENNE MATITE EVIDENZIATORI QUADERNI ACCENDINI

2026 GENERAL CATALOGUE

Co-create with



Let's design creative solutions
that make your brand even more unforgettable.

Think BIC



 **BIC**[®] *graphic*
Your Brand Ambassador



Our story began in 1944, as part of everyday life. Today, we also stand alongside brands, positioning them in the best placement in the world: in people's lives.



FR/
Notre histoire a commencé en 1944, faisant partie du quotidien. Aujourd'hui, nous sommes également aux côtés des marques, en les positionnant au meilleur endroit du monde : dans la vie des gens.

IT/
La nostra storia inizia nel 1944, come parte della vita di tutti i giorni. Oggi siamo anche al fianco dei brand, per posizionarli nel posto migliore del mondo: nella vita delle persone.

DE/
Unsere Geschichte begann 1944, als Teil des Alltags. Heute stehen wir auch an der Seite von Marken und positionieren sie am besten Platz der Welt: im Leben der Menschen.

ES/
Nuestra historia comenzó en 1944, como parte de la vida cotidiana. Hoy, también estamos junto a las marcas, posicionándolas en el mejor lugar del mundo: en la vida de las personas.

Discover how!



BIC GRAPHIC

2

Our Story	2	Sustainable Products	20
Welcome to the universe of BIC...	6	Ecolutions® Novelties	22
That's why we invite you to: Co-create with us	8	BIC® 4 Colours® ECO	24
An Icon	10	BIC® Media Clic Advance	26
Connection	12	BIC® Cristal® Re'new™ Black	28
Trust	14	BIC® M10® Clic	30
Let's customise every product consciously	16	BIC® Highlighter Flat	32
Sustainable Innovation	18		

BIC® WRITING INSTRUMENTS

34

BALLPENS

BIC® Cristal® Expression	38	BIC® 4 Colours® Gradient	124
BIC® Cristal® Re'New™	40	BIC® 4 Colours® Pastel	126
BIC® Cristal® Re'New™ Black	42	BIC® 4 Colours® Fashion	128
BIC® Style	44	BIC® 4 Colours® Sun	130
BIC® Round Stic®	48	BIC® 4 Colours® Fine	132
BIC® Round Stic® Ecolutions®	51	BIC® 4 Colours® Fluo	134
BIC® M10® Clic	54	BIC® 4 Colours® Glacé	136
BIC® Media Clic	60	BIC® 4 Colours® Shine	138
BIC® Media Clic Advance	58	BIC® 4 Colours® Soft	140
BIC® Media Clic Ecolutions®	61	BIC® 4 Colours® Wood Style	142
BIC® Media Clic Ecolutions® Plus	62	BIC® 4 Colours® Flags Collection	144
BIC® Media Clic Grip	65	BIC® 4 Colours® 3+1 ^{HB}	146
BIC® Media Clic Grip Ecolutions®	66		
BIC® Media Clic BGuard™ antibacterial	70	METALLIC PENS	
BIC® Media Clic BGuard™ antimicrobial Ecolutions®	72	BIC® Metal Pro	148
BIC® Media Clic Biobased Ecolutions®	74		
BIC® Media Clic Biobased BGuard™ antibacterial	76	ROLLERS AND GELS	
BIC® Media Clic Shine	78	BIC® Grip Roller	154
BIC® Media Clic Glacé	80	BIC® Intensity® Gel Clic	156
BIC® Clic Stic	82		
BIC® Clic Stic Ecolutions®	83	HIGHLIGHTERS AND MARKERS	
BIC® Clic Stic Softfeel®	85	BIC® Brite Liner® Grip	160
BIC® Clic Stic Stylus	86	BIC® Highlighter Flat	162
BIC® Clic Stic Stylus Ecolutions®	86	BIC® Velleda® White Board Marker Fine	164
BIC® Super Clip	92	BIC® Velleda® White Board Marker Grip	165
BIC® Super Clip Ecolutions®	93	BIC® Mark-It Permanent Marker	166
BIC® Super Clip Advance	96	BIC® Permanent Marker Ecolutions®	167
BIC® Super Clip Glacé	96		
BIC® Super Clip Glacé Advance	100	MECHANICAL PENCILS	
BIC® Super Clip Soft	102	BIC® Matic®	170
BIC® Super Clip Soft Advance	103	BIC® Media Clic Mechanical pencil	172
BIC® Super Clip Origin	104	BIC® Media Clic Grip Mechanical pencil	173
BIC® Wide Body™	108	BIC® Media Clic Grip Mechanical pencil Ecolutions®	173
BIC® Wide Body™ Ecolutions®	109		
BIC® Wide Body™ Mini Digital	110	PENCILS	
BIC® 4 Colours®	116	BIC® Evolution® Ecolutions®	178
BIC® 4 Colours® ECO	118	BIC® Kids Evolution® Colouring Set	182
BIC® 4 Colours® Rainbow Decor	120	Sprout™ Graphite pencil	184
BIC® 4 Colours® Bicolor	122		

CONTENTS

OTHER WRITING INSTRUMENTS 186

PLASTIC PENS

Basic Pen	190
Click Pen	192
Striped Grip Pen	194

STYLUS PENS

Sleek Stylus Pen	198
------------------	-----

NOTEBOOKS 200

BIC® PARTNER

BIC® Partner Hard Cover	204	BIC® Partner FruitCover	208
BIC® Partner Flex Cover	206	BIC® Partner Notebooks Tailormade Service	210

BIC®/DJEEP® LIGHTERS AND BIC® CASES 212

BIC® LIGHTERS

BIC® J25 Lighter	218
BIC® J23 Lighter	222
BIC® J26 Lighter	226
BIC® J38 Lighter	230
BIC® EZ Reach™ Lighter	234

OTHER PRODUCTS

BIC® Pocket Ashtray	244
---------------------	-----

DJEEP® LIGHTERS

DJEEP® D1 Lighter	248
-------------------	-----

BIC® LIGHTER CASES

BIC® Styl'it Luxury Case	238
BIC® Aluminium Flat Case	240
BIC® Clip Case	241
BIC® 3D Case	242

BIC® PACKAGING 254

BIC® Primary Ecolutions® Packaging	258	BIC® Secondary Packaging	264
BIC® Primary Packaging	258		

GENERAL INFORMATION 266

Make it simple!	270	Product index	278
Symbols and abbreviations	272	Colour table	279
Technical Parameters for each Type of Printing	277		

Welcome to the universe of BIC...

Since 1944, our BIC Group has brought joy through simplicity, turning BIC into a global icon, loved across the world.

— **Trusted by millions, every day.**

FR/

Bienvenue dans l'univers du BIC...

Depuis 1944, notre Groupe BIC apporte de la joie grâce à la simplicité, faisant de BIC une icône mondiale, aimée dans le monde entier. — **Comptant avec la confiance de millions de personnes, chaque jour.**

IT/

Benvenuti nell'universo BIC...

Dal 1944, il Gruppo BIC porta gioia attraverso la semplicità, trasformando BIC in un'icona globale amata in tutto il mondo. — **Scelta e apprezzata da milioni di persone, ogni giorno.**

DE/

Willkommen im Universum von BIC...

Seit 1944 bringt die BIC Gruppe Freude durch Einfachheit und hat BIC zu einer globalen Ikone gemacht, die auf der ganzen Welt geliebt wird. — **Millionen Menschen vertrauen uns täglich.**

ES/

Bienvenido al universo BIC...

Desde 1944, nuestro Grupo BIC ha transmitido alegría a través de la sencillez, convirtiendo la marca BIC en un icono global, amado en todo el mundo. — **Con la confianza de millones de personas, cada día.**

FR/

BIC : Des produits iconiques que tout le monde aime. Pour tous !
BIC Graphic : Des solutions d'impression créatives et avancées. Pour les professionnels !

DE/

BIC: Legendäre Produkte, die Menschen lieben. Für alle!
BIC Graphic: Kreative und fortschrittliche Drucklösungen. Für Unternehmen!

IT/

BIC: Prodotti iconici che le persone amano. Per tutti!
BIC Graphic: Soluzioni di stampa creative e avanzate. Per i professionisti!

ES/

BIC: Productos icónicos que la gente ama. ¡Para todos!
BIC Graphic: Soluciones de impresión creativas y avanzadas. ¡Para profesionales!



*Iconic products
that people love.
For everyone!*

*Creative and
advanced printing
solutions.
For professionals!*



... and BIC Graphic's world!

We go beyond decorated products: we celebrate 30 years of designing brand stories that truly last.

— From iconic products to creative solutions.

FR/

... et dans le monde de BIC Graphic !

Nous allons au-delà des produits décorés : nous célébrons 30 ans à concevoir des histoires de marque qui durent vraiment.

— Des produits iconiques aux solutions créatives.

IT/

... e nel mondo di BIC Graphic!

Andiamo oltre i prodotti decorati: celebriamo 30 anni dedicati a creare storie di marchi che durano davvero.

— Dai prodotti iconici alle soluzioni creative.

DE/

... und in der Welt von BIC Graphic!

Wir gehen über dekorierte Produkte hinaus: Wir feiern 30 Jahre, in denen wir Markengeschichten gestalten, die wirklich Bestand haben. — Von ikonischen Produkten bis zu kreativen Lösungen.

ES/

... y al mundo de BIC Graphic!

Vamos más allá de los productos decorados: celebramos 30 años diseñando historias de marca que perduran.

— De productos icónicos a soluciones creativas.

That's why we invite you to: **Co-create** with us.

Let's design creative solutions that make your brand even more unforgettable.

We combine creativity, advanced printing technologies, and technical expertise to craft solutions that stand out, inspire, and connect.

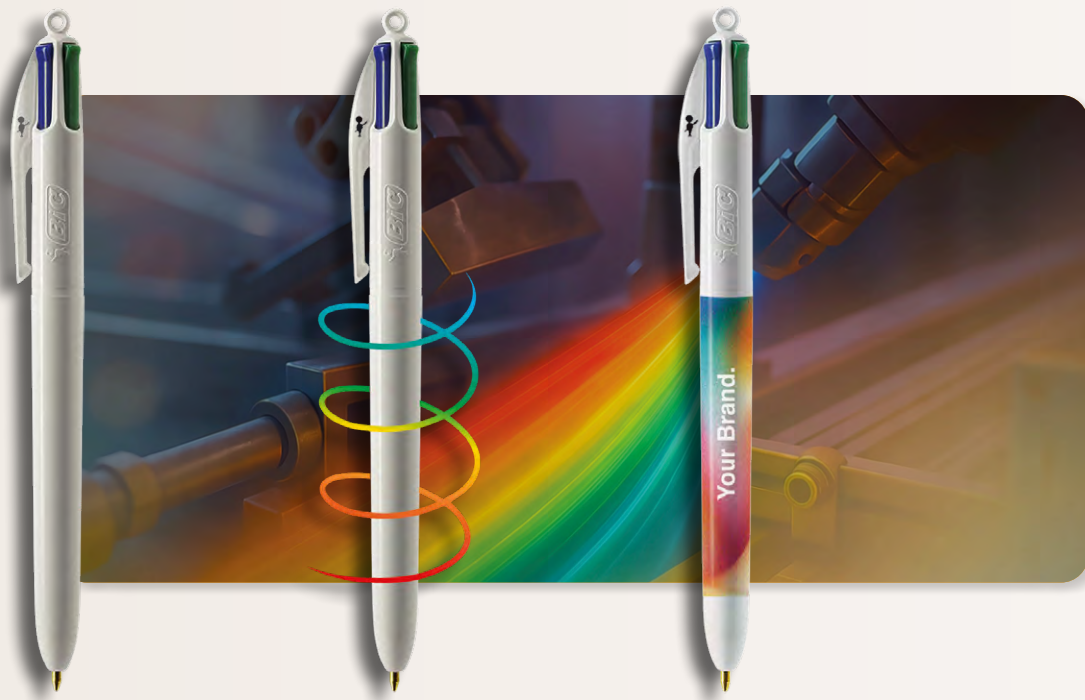

FR/

C'est pourquoi nous vous invitons à : Créer avec nous.

Concevons ensemble des solutions créatives pour rendre votre marque encore plus remarquable.

Nous allions créativité, technologies d'impression avancées et expertise technique pour concevoir des solutions qui se distinguent, inspirent et créent des liens.

IT/

Ecco perché ti invitiamo a: Creare insieme a noi.

Progettiamo insieme soluzioni creative che rendano il tuo marchio ancora più impattante.

Unendo creatività, tecnologie di stampa avanzate ed esperienza tecnica, realizziamo soluzioni che si distinguono, ispirano e connettono.

DE/

Deshalb laden wir Sie ein: Gestalten Sie mit uns.

Gemeinsam gestalten wir kreative Lösungen, die Ihre Marke unvergesslicher denn je machen.

Wir verbinden Kreativität, modernste Drucktechnologien und technisches Know-how, um Lösungen zu schaffen, die herausragen, inspirieren und verbinden.

ES/

Por eso te invitamos a: Crear con nosotros.

Diseñemos juntos soluciones creativas que hagan tu marca aún más inolvidable.

Combinamos creatividad, tecnologías avanzadas de impresión y experiencia técnica para crear soluciones que destaquen, inspiren y conecten.

Customised!



360° Design

"Co-create with us"
also means co-create with...

**AN
ICON**



FR/
"Créer avec nous" signifie aussi créer avec...
UNE ICÔNE

DE/
"Gestalten Sie mit uns" bedeutet auch,
gemeinsam zu kreieren mit... **EINER IKONE**

IT/
"Creare insieme a noi" significa anche creare
con... **UN'ICONA**

ES/
"Crear con nosotros" también significa crear
con... **UN ICONO**



And
innovation

- ✓ Reinvented iconic products with new possibilities.
- ✓ Creative and technological capabilities: advanced printing, design, customisation.

FR/

Et innovation

- ✓ Des produits iconiques réinventés avec de nouvelles possibilités.
- ✓ Des capacités créatives et technologiques : impression avancée, design, personnalisation.

IT/

E innovazione

- ✓ Prodotti iconici reinventati con nuove possibilità.
- ✓ Capacità creative e tecnologiche: stampa avanzata, design, personalizzazione. Soluzioni che rendono i brand indimenticabili.

DE/

Und Innovation

- ✓ Ikonische Produkte, neu erfunden mit neuen Möglichkeiten.
- ✓ Kreative und technologische Kompetenzen: fortschrittlicher Druck, Design, Personalisierung. Lösungen, die Marken unvergesslich machen.

ES/

E innovación

- ✓ Productos icónicos reinventados con nuevas posibilidades.
- ✓ Capacidades creativas y tecnológicas: impresión avanzada, diseño y personalización. Soluciones que hacen que las marcas sean inolvidables.

“Co-create with us” also means co-create with...

CONNECTION

- ✓ Real proximity to customers: made in Europe, native-speaking customer service, local sales teams.
- ✓ BIC® products are present in every life stage.
- ✓ Emotional and cultural connection with each market.

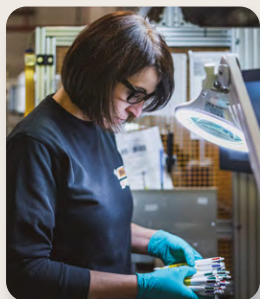

FR/

“Créer avec nous” signifie aussi créer avec...

CONNEXION

- ✓ Une véritable proximité avec nos clients : fabrication en Europe, service client dans leur langue, équipes commerciales locales.
- ✓ Les produits BIC® accompagnent chaque étape de la vie.
- ✓ Une connexion émotionnelle et culturelle avec chaque marché.

IT/

“Creare insieme a noi” significa anche creare con... CONNESSIONE

- ✓ Una vera vicinanza ai clienti: produzione in Europa, servizio clienti madrelingua, team commerciali locali.
- ✓ I prodotti BIC® accompagnano ogni fase della vita.
- ✓ Una forte connessione emozionale e culturale con ogni mercato.

DE/

“Gestalten Sie mit uns” bedeutet auch, gemeinsam zu kreieren mit... VERBINDUNG

- ✓ Echte Nähe zu unseren Kunden: hergestellt in Europa, muttersprachlicher Kundenservice, lokale Vertriebsteams.
- ✓ BIC® Produkte begleiten alle Lebensphasen.
- ✓ Emotionale und kulturelle Verbindung zu jedem Markt.

ES/

“Crear con nosotros” también significa crear con... CONEXIÓN

- ✓ Estamos cerca de nuestros clientes: fabricación europea, atención personalizada y equipos locales en cada país.
- ✓ Los productos BIC® forman parte de cada etapa de la vida.
- ✓ Conectamos emocional y culturalmente con cada mercado.

At BIC Graphic,
we put your brand
in the best place in
the world:
in people's lives.

Every day!



Tarragona,
Spain

Made in Europe!

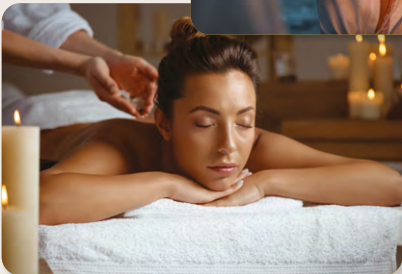

FR/
Chez BIC Graphic, nous mettons votre marque dans le meilleur emplacement au monde : dans la vie des gens.

DE/
Bei BIC Graphic platzieren wir Ihre Marke am besten Ort der Welt: im Leben der Menschen.

IT/
In BIC Graphic mettiamo il tuo brand nel miglior posto del mondo: nella vita delle persone.

ES/
En BIC Graphic ponemos tu marca en el mejor lugar del mundo: en la vida de las personas.

BIC GRAPHIC

BIC® WRITING INSTRUMENTS

OTHER WRITING INSTRUMENTS

NOTEBOOKS

BIC® / DIEEP® LIGHTERS AND BIC® CASES

BIC® PACKAGING

GENERAL INFORMATION

"Co-create with us" also means co-create with...



TRUST



- ✓ Sustainable product design: long-lasting, minimal materials.
- ✓ Local production and decoration powered by 100% renewable energy.
- ✓ Certified quality and responsible manufacturing.

FR/

"Créer avec nous" signifie aussi créer avec...

CONFIANCE

- ✓ Conception de produits durables : longue durée de vie, matériaux minimaux.
- ✓ Production et décoration locales, alimentées à 100 % par des énergies renouvelables.
- ✓ Qualité certifiée et fabrication responsable.

IT/

"Creare insieme a noi" significa anche creare

con... FIDUCIA

- ✓ Design di prodotto sostenibile: lunga durata, uso minimo di materiali.
- ✓ Produzione e decorazione locale, alimentata al 100% da energia rinnovabile.
- ✓ Qualità certificata e produzione responsabile.

DE/

"Gestalten Sie mit uns" bedeutet auch, gemeinsam zu kreieren mit... VERTRAUEN

- ✓ Nachhaltiges Produktdesign: langlebig, mit minimalem Materialeinsatz.
- ✓ Lokale Produktion und Veredelung, betrieben mit 100 % erneuerbarer Energie.
- ✓ Zertifizierte Qualität und verantwortungsvolle Herstellung.

ES/

"Crear con nosotros" también significa crear con...

CONFIANZA

- ✓ Diseño de productos sostenibles: duraderos y materiales mínimos.
- ✓ Producción y personalización locales, impulsadas por electricidad proveniente de fuentes renovables
- ✓ Calidad certificada y fabricación responsable.

Co-create a better future

FR/
Créons un meilleur avenir

DE/
Gemeinsam eine bessere Zukunft gestalten

IT/
Creiamo un futuro migliore

ES/
Creemos un futuro mejor



Let's customise every product consciously.



MADE IN EUROPE

By keeping production close to our clients, we reduce transport distances, minimise emissions, and maintain full control over the entire value chain.



FR/

Personnalisons chaque produit de manière responsable.

1. FABRIQUÉ EN EUROPE

En gardant la production proche de nos clients, nous réduisons les distances de transport, minimisons les émissions et maintenons un contrôle total sur l'ensemble de la chaîne de valeur.

IT/

Personalizziamo ogni prodotto in modo consapevole.

1. PRODOTTO IN EUROPA

Mantenendo la produzione vicino ai nostri clienti, riduciamo le distanze di trasporto, minimizziamo le emissioni e manteniamo il pieno controllo su tutta la catena del valore.

DE/

Lassen Sie uns jedes Produkt bewusst individualisieren.

1. HERGESTELLT IN EUROPA

Indem wir die Produktion in Kundennähe halten, verkürzen wir Transportwege, minimieren Emissionen und behalten die volle Kontrolle über die gesamte Wertschöpfungskette.

ES/

Personalicemos cada producto de forma consciente.

1. HECHO EN EUROPA

Al mantener la producción cerca de nuestros clientes, reducimos las distancias de transporte, minimizamos las emisiones y mantenemos el control total sobre toda la cadena de valor.

BUILT TO LAST

+3,000
lights



Durable products require fewer replacements, helping to reduce overall waste and resource consumption over time, with a long-lasting impact.

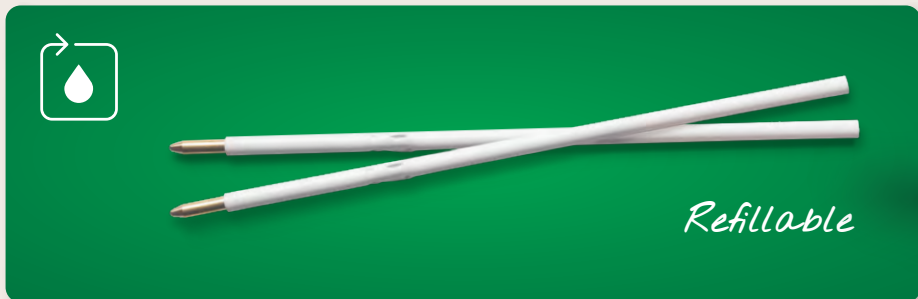

FR/
2. CONÇU POUR DURER
Des produits durables qui sont moins à remplacer, ce qui contribue à réduire les déchets et la consommation de ressources au fil du temps, avec un impact durable.

IT/
2. FATTO PER DURARE
I prodotti durevoli richiedono meno sostituzioni, contribuendo a ridurre nel tempo i rifiuti e il consumo di risorse, con un impatto duraturo.

DE/
2. GEMACHT, UM ZU HALTEN
Langlebige Produkte müssen seltener ersetzt werden – das hilft, Abfall und Ressourcenverbrauch langfristig zu reduzieren und hat einen nachhaltigen Effekt.

ES/
2. DISEÑADO PARA DURAR
Los productos duraderos requieren menos reemplazos, lo que ayuda a reducir los residuos y el consumo de recursos a lo largo del tiempo, con un impacto duradero.

SUSTAINABLE INNOVATION

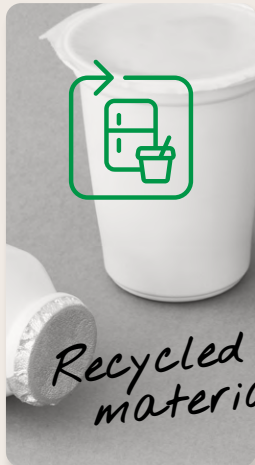

Our facilities prioritise the use of alternative, sustainable materials, and operate with electricity sourced 100% from renewable energy.



FR/
3. INNOVATION DURABLE
Nos installations privilégient l'utilisation de matériaux alternatifs et durables, et fonctionnent avec de l'électricité issue à 100 % d'énergies renouvelables.

IT/
3. INNOVAZIONE SOSTENIBILE
I nostri impianti privilegiano l'uso di materiali alternativi e sostenibili e operano con elettricità proveniente al 100% da fonti di energia rinnovabile.

DE/
3. NACHHALTIGE INNOVATION
Unsere Fabriken legen den Schwerpunkt auf die Verwendung alternativer, nachhaltiger Materialien und werden mit 100 % Strom aus erneuerbaren Energien betrieben.

ES/
3. INNOVACIÓN SOSTENIBLE
Nuestras instalaciones priorizan el uso de materiales alternativos y sostenibles, y funcionan con electricidad procedente al 100 % de fuentes de energía renovable.



EDUCATION MATTERS

Thanks to the BIC Corporate Foundation, more than 210 million children have benefited from our education initiatives.

Our goal: to empower 250 million young learners worldwide.

Opportunities and social impact!

→ OUR CERTIFICATES



ecovadis



United Nations
Global Compact



Sedex² | Member



FR/

L'ÉDUCATION COMPTE

Grâce à la Fondation d'entreprise BIC, plus de 210 millions d'enfants ont bénéficié de nos initiatives en faveur de l'éducation. Notre objectif : donner les moyens à 250 millions de jeunes apprenants dans le monde entier.

NOS CERTIFICATIONS (voir le tableau)

IT/

L'ISTRUZIONE CONTA

Grazie alla Fondazione aziendale BIC, oltre 210 milioni di bambini hanno beneficiato delle nostre iniziative per l'istruzione. Il nostro obiettivo: dare opportunità a 250 milioni di giovani studenti in tutto il mondo.

LE NOSTRE CERTIFICAZIONI (vedi tabella)

DE/

BILDUNG ZÄHLT

Dank der BIC Corporate Foundation haben mehr als 210 Millionen Kinder von unseren Bildungsinitiativen profitiert. Unser Ziel: 250 Millionen junge Lernende weltweit zu fördern und zu unterstützen.

UNSERE ZERTIFIKATE: siehe Abbildung oben

ES/

LA EDUCACIÓN IMPORTA

Gracias a la Fundación Corporativa BIC, más de 210 millones de niños se han beneficiado de nuestras iniciativas educativas. Nuestro objetivo: empoderar a 250 millones de jóvenes estudiantes en todo el mundo.

NUESTRAS CERTIFICACIONES (ver tabla)

What does this symbol means?



The Möbius loop indicates the product's recycled content.

A percentage inside the symbol specifies the exact amount of recycled plastic used. A line of text below the symbol states the calculation basis for determining the percentage by weight.

Simple. Clear. Transparent.

At BIC®, we turn everyday waste into new possibilities - from car parts to yogurt pots and fruit trays.



Plastic car parts



Refrigerators and yogurt containers



Fruit and vegetable trays



Pharmaceutical waste

For example:

Our BIC® Media Clic Ecolutions® Plus is made from 98% recycled plastic in its external parts.

ecolutions®



MADE FROM 98% RECYCLED MATERIAL*
*excl. ink system



PLASTIC CAR PARTS

LOOK FOR THE SYMBOL THROUGHOUT THE CATALOGUE

AND DISCOVER WHICH PRODUCTS ARE ALREADY

HELPING REDUCE ENVIRONMENTAL IMPACT.



FR/ Que signifie ce symbole ?

Le symbole Möbius indique la teneur en matières recyclées du produit.

Le pourcentage indiqué à l'intérieur du symbole précise la quantité exacte de plastique recyclé utilisé. Une ligne de texte sous le symbole indique la base de calcul utilisée pour déterminer le pourcentage en poids.

Simple. Clair. Transparent.

Chez BIC®, nous transformons les déchets quotidiens en nouvelles possibilités, des pièces automobiles aux pots de yaourt et aux barquettes de fruits.

DE/ Was bedeutet dieses Symbol?

Die Möbiusschleife kennzeichnet den Recyclinganteil des Produkts.

Der Prozentsatz innerhalb des Symbols gibt die genaue Menge des verwendeten recycelten Kunststoffes an. Der Text unterhalb des Symbols nennt die Berechnungsgrundlage für die Ermittlung des Gewichtsanteils.

Einfach. Klar. Transparent.

Bei BIC® verwandeln wir alltägliche Abfälle in neue Möglichkeiten - von Autoteilen über Joghurtbecher bis hin zu Obstschalen.

IT/ Cosa significa questo simbolo?

Il simbolo del nastro di Möbius indica il contenuto riciclato del prodotto.

La percentuale all'interno del simbolo specifica l'esatta quantità di plastica riciclata utilizzata. Una riga di testo sotto il simbolo indica la base di calcolo utilizzata per determinare la percentuale in peso.

Semplice. Chiaro. Trasparente.

Noi di BIC® trasformiamo i rifiuti quotidiani in nuove possibilità: dai ricambi per auto ai vassetti di yogurt e ai vassoi per la frutta.

ES/ ¿Qué significa este símbolo?

El símbolo del Möbius indica el contenido reciclado del producto.

El porcentaje que aparece dentro del símbolo especifica la cantidad exacta de plástico reciclado utilizado. La línea de texto situada debajo del símbolo indica la base de cálculo para determinar el porcentaje en peso.

Sencillo. Claro. Transparente.

En BIC®, convertimos los residuos cotidianos en nuevas posibilidades, desde piezas de automóviles, hasta envases de yogur y bandejas de fruta.

SUSTAINABLE PRODUCTS



Made from scrap plastic car parts.



- BIC® MEDIA CLIC GRIP ECOLUTIONS®
- BIC® MEDIA CLIC ECOLUTIONS®
- BIC® MEDIA CLIC ECOLUTIONS® PLUS
- BIC® SUPER CLIP ECOLUTIONS®
- BIC® 4 COLOURS® ECO



Made from sugar cane.



- BIC® MEDIA CLIC BIOBASED ECOLUTIONS®



Made from biobased material.



- BIC® SUPER CLIP ORIGIN



FSC and recyclable cardboard.



- SPROUT™ GRAPHITE PENCIL



Made from recycled fridges and yogurt pots.



- BIC® EVOLUTION® ECOLUTIONS®

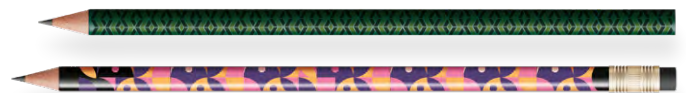

- BIC® KIDS EVOLUTION® ECOLUTIONS® COLOURING SET



Made from pharmaceutical waste.



- BIC® PERMANENT MARKER ECOLUTIONS®



Made from scrap fruit and vegetables trays.



- BIC® WIDE BODY™ ECOLUTIONS®
- BIC® CLIC STIC ECOLUTIONS®
- BIC® ROUND STIC® ECOLUTIONS®



BIC® GRAPHIC

BIC® WRITING INSTRUMENTS

OTHER WRITING INSTRUMENTS

NOTEBOOKS

BIC® / DIEEP® LIGHTERS AND BIC® CASES

BIC® PACKAGING

GENERAL INFORMATION

Recycled products for your creative ideas!

An absolute win-win for the planet and your projects. The **BIC® Media Clic Ecolutions® Plus** and **BIC® Kids Evolution® Colouring Set** are crafted from recycled materials, using FSC-certified paper and sustainable packaging. With Ecolutions®, the responsible choice is also the most practical and creative one.

SUSTAINABLE PRODUCTS MADE FROM RECYCLED MATERIALS



FRIGIDES AND YOGURT POTS



PLASTIC CAR PARTS

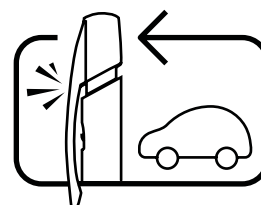

New unbreakable clip made from recycled car parts, available in black and white!



FR/
Des produits recyclés pour vos idées créatives !
Une situation de victoire absolue : pour la planète et pour vos projets. Les **BIC® Media Clic Ecolutions® Plus** et **BIC® Kids Evolution® Colouring Set** sont conçus avec des matériaux recyclés, du papier certifié FSC et des emballages durables. Avec **Ecolutions®**, le choix responsable est aussi le plus pratique et le plus créatif.

DE/
Recyclingprodukte für Ihre kreativen Ideen!
Eine absolute Win-Win-Situation: für den Planeten und für Ihre Projekte. **BIC® Media Clic Ecolutions® Plus** und **BIC® Kids Evolution® Colouring Set** werden aus recycelten Materialien, FSC-zertifiziertem Papier und nachhaltigen Verpackungen hergestellt. Mit **Ecolutions®** ist die verantwortungsvolle Wahl auch die praktischste und kreativste.

IT/
Prodotti riciclati per le tue idee creative!
Una situazione vincente sotto ogni aspetto: per il pianeta e per i tuoi progetti. I **BIC® Media Clic Ecolutions® Plus** e **BIC® Kids Evolution® Colouring Set** sono progettati con materiali riciclati, carta certificata FSC e imballaggi sostenibili. Con **Ecolutions®**, la scelta responsabile è anche la più pratica e creativa.

ES/
¡Productos reciclados para tus ideas creativas!
Una solución donde ganan todos: el planeta y tus proyectos. El **BIC® Media Clic Ecolutions® Plus** y el **BIC® Kids Evolution® Colouring Set** están diseñados con materiales reciclados, papel con certificación FSC y embalajes sostenibles. Con **Ecolutions®**, la elección responsable es también la más práctica y creativa.

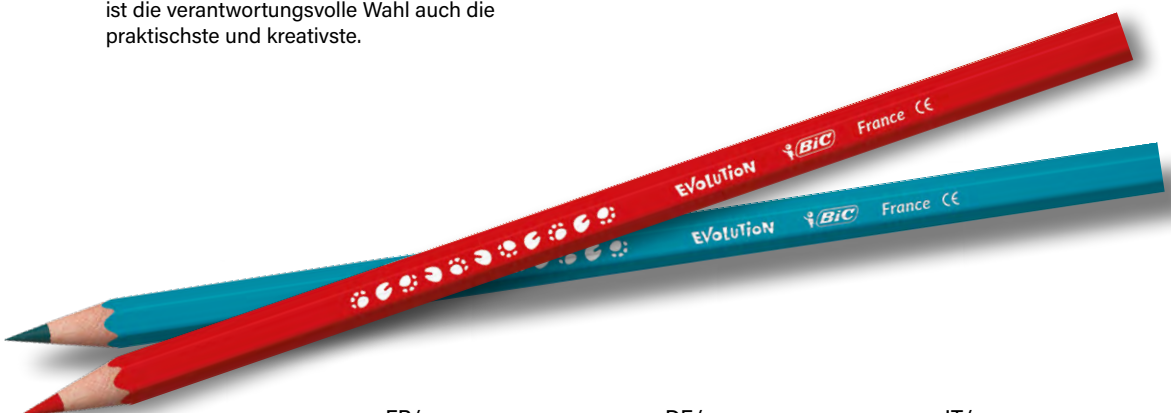

FR/
Clip incassable, désormais fabriqué à partir de matériaux recyclés.

DE/
Bruchsicherer Clip, hergestellt aus recyceltem Kunststoff aus Autoteilen.

IT/
Clip infrangibile, ora realizzata con materiale riciclato.

ES/
Clip irrompible, ahora fabricado con material reciclado.



NEW!

BIC® Kids Evolution® Colouring Set
12 units

BIC® Kids Evolution® Colouring Set
6 units



NEW!

BIC® Media Clic
Evolution® Plus



BIC
GRAPHIC

BIC®
WRITING INSTRUMENTS

OTHER WRITING
INSTRUMENTS

NOTEBOOKS

BIC® / DIEEP® LIGHTERS
AND BIC® CASES

BIC®
PACKAGING

GENERAL
INFORMATION

The iconic driver of change

Big changes begin with incredible milestones. This one has arrived in the form of the first **BIC® 4 Colours® ECO**, whose barrel is made from 98% recycled plastic coming from car parts*. But this is just the beginning because you will write the next chapter of sustainable change.

Make your mark with the new BIC® 4 Colours® ECO.

FR/

Le moteur iconique du changement.

Les grands changements commencent par des étapes incroyables. Le premier **BIC® 4 Couleurs® ECO**, dont le corps est fabriqué à partir de 98 % de plastique recyclé provenant de pièces automobiles recyclées*, en est un exemple. Mais ce n'est que le début, car vous écrirez le prochain chapitre du changement durable. Laissez votre marque avec le nouveau BIC® 4 Couleurs® ECO.

DE/

Der legendäre Antrieb für Veränderung.

Große Veränderungen beginnen mit unglaublichen Meilensteinen. Ein solcher Meilenstein ist der erste **BIC® 4 Colours® ECO**, dessen Schaft zu 98 % aus recyceltem Kunststoff aus Autoteilen hergestellt ist*. Doch das ist erst der Anfang, denn Sie werden das nächste Kapitel der nachhaltigen Veränderung schreiben. Setzen Sie Ihr Zeichen mit dem neuen BIC® 4 Colours® ECO.

IT/

Il motore iconico del cambiamento

I grandi cambiamenti iniziano con traguardi incredibili. È arrivato sotto forma della prima **BIC® 4 Colours® ECO**, il cui corpo è realizzato con il 98% di plastica riciclata proveniente da parti di automobili.* Ma questo è solo l'inizio, perché sarai tu a scrivere il prossimo capitolo del cambiamento sostenibile. Lascia il tuo segno con la nuova BIC® 4 Colours® ECO.

ES/

El motor icónico del cambio.

Los grandes cambios comienzan con hitos increíbles. El primer **BIC® 4 Colours® ECO**, cuyo cuerpo está fabricado con un 98% de plástico reciclado procedente de piezas de automóviles*, es prueba de ello. Pero esto es solo el principio, porque tú escribirás el próximo capítulo del cambio sostenible. Deja tu marca con el nuevo BIC® 4 Colours® ECO.

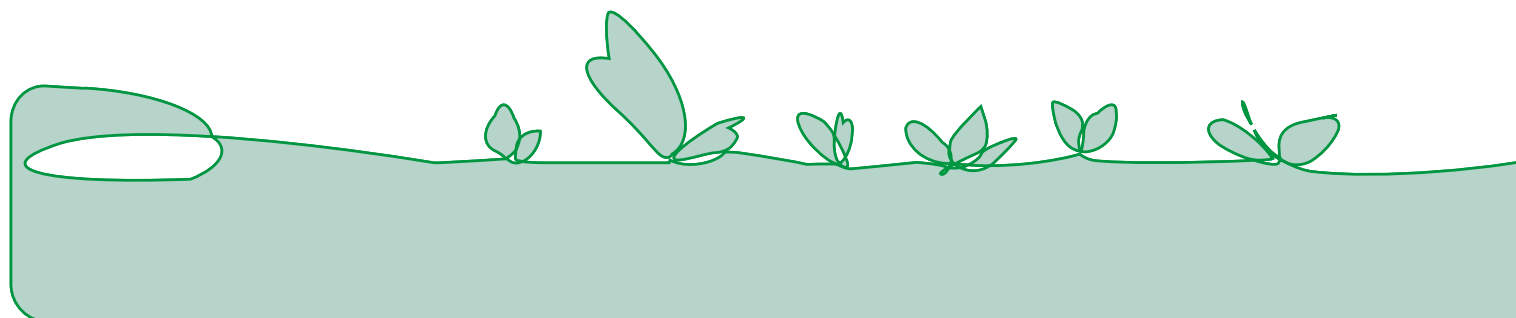
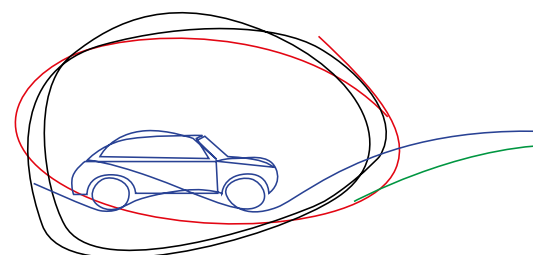



NEW!

BIC® 4 Colours® ECO



Made of 98% recycled plastic coming from car parts*.

Barrel

FR/ Fabriqué à partir de 98 % de plastique recyclé provenant de pièces automobiles*.

DE/ Hergestellt aus 98 % recyceltem Kunststoff aus Autoteilen*.

IT/ Realizzato con il 98% di plastica riciclata proveniente da parti di automobili*.

ES/ Fabricado con un 98 % de plástico reciclado procedente de piezas de automóviles*.

* The percentage is calculated based on total weight of the barrel. Due to the recycled content of the raw materials used to make the product, we cannot guarantee that the colours shown in the catalogue or colours customised to order will always have the same colour and appearance.

Style that clicks

A refined evolution of our bestselling classic.
Now featuring a silver section, refillable ink system,
and endless customisation possibilities.
Your brand deserves a pen that's as sleek as it is smart.

NEW!

BIC® Media Clic
Advance



Refillable
FR/ Rechargeable
DE/ Nachfüllbar
IT/ Ricaricabile
ES/ Recargable



FR/
Un style qui séduit
Une évolution raffinée de notre classique best-seller. Désormais doté d'une section argentée, d'un système d'encre rechargeable et d'innombrables possibilités de personnalisation. *Parce que votre marque mérite un stylo aussi élégant qu'intelligent.*

DE/
Stil, der überzeugt
Eine raffinierte Weiterentwicklung unseres Bestsellers. Jetzt mit silberner Spitze, nachfüllbarem Tintensystem und vielfältigen Personalisierungsmöglichkeiten. *Denn Ihre Marke verdient einen Kugelschreiber, der elegant wie clever ist.*

IT/
Uno stile che colpisce
Una raffinata evoluzione del nostro classico best seller. Ora con puntale argentato, sistema di ricarica dell'inchiostro e infinite possibilità di personalizzazione. *Perché il tuo marchio merita una penna elegante e intelligente.*

ES/
Estilo que cautiva
Una nueva versión más elegante de nuestro clásico superventas. Ahora con una sección plateada, sistema de recarga de tinta y un sinfín de posibilidades de personalización. *Porque tu marca merece un bolígrafo tan elegante como inteligente.*



NEW!

BIC Media Clic
Advance



Endless Customisation

FR/ Personnalisation infinie
DE/ Vielfältige Personalisierungsmöglichkeiten
IT/ Personalizzazione infinita
ES/ Personalización sin límites

Sleek

FR/ Élégant DE/ Elegant
IT/ Elegante ES/ Elegante



Unbreakable clip

FR/ Clip incassable
DE/ Bruchsicherer Clip
IT/ Clip infrangibile
ES/ Clip irrompible



Refillable
FR/ Rechargeable
DE/ Nachfüllbar
IT/ Ricaricabile
ES/ Recargable

Sustainable

FR/ Durable
DE/ Nachhaltig
IT/ Sostenibile
ES/ Sostenible

BIC GRAPHIC

BIC® WRITING INSTRUMENTS

OTHER WRITING INSTRUMENTS

NOTEBOOKS

BIC® / DIIEP® LIGHTERS AND BIC® CASES

BIC® PACKAGING

GENERAL INFORMATION

Chic. Bold. Timeless

Elevate your writing with the **BIC® Cristal® Re'New Black** — the classic pen reimaged with a sleek, glossy black finish. Elegant, comfortable, and designed to last, this premium refillable ballpoint supports a more sustainable choice.

NEW!

BIC® Cristal®
Re'New™
Black



**Write in black
or blue!
Always in style.**

FR/ Écrivez en noir ou en bleu ! Toujours à la mode.

DE/ Schreiben Sie in Schwarz oder Blau! Immer stilvoll.

IT/ Scrivi in nero o blu! Sempre alla moda.

ES/ ¡Escribe en negro o azul! Siempre a la moda.



FR/

Chic. Audacieux. Intemporel.

Améliorez votre écriture avec le **BIC® Cristal® Re'New™ Black**, le stylo classique revisité avec une finition noire brillante et élégante. Chic, confortable et conçu pour durer, ce stylo à bille rechargeable haut de gamme est un choix plus durable.

DE/

Schick. Auffällig. Zeitlos.

Veredeln Sie Ihre Handschrift mit dem **BIC® Cristal® Re'New™ Black** – dem klassischen Kugelschreiber in neuem Design mit edler, glänzender schwarzer Oberfläche. Dieser hochwertige, nachfüllbare Kugelschreiber ist elegant, komfortabel und langlebig und somit eine nachhaltige Wahl.

IT/

Chic. Audace. Intramontabile.

Migliora la tua scrittura con la **BIC® Cristal® Re'New™ Black**, la classica penna ripensata con un'elegante finitura nera lucida. Chic, comoda e progettata per durare, questa penna a sfera ricaricabile di alta qualità rappresenta una scelta più sostenibile.

ES/

Chic. Atrevido. Atemporal.

Mejora tu escritura con el **BIC® Cristal® Re'New™ Black**, el clásico bolígrafo rediseñado con un elegante acabado negro brillante. Chic, cómodo y diseñado para durar, este bolígrafo recargable de alta calidad es una opción más sostenible.

Chic. Bold. Timeless.



Sleek Metallic Black Body:
Modern, glossy finish for a sophisticated look.

Iconic Hexagonal Shape:
Comfortable, controlled grip for smooth writing.

Refillable Design: Includes 1 black ink refill and 1 extra blue ink refill for extended use.

Long-Lasting & Sustainable:
Refillable for continued use, reducing waste.

Perfect for Any Occasion:
Professional writing, gifting, or everyday style.

FR/

- Corps noir métallique élégant
- Forme hexagonale emblématique
- Conception rechargeable
- Durable et écologique
- Parfait pour toutes les occasions

DE/

- Schlanker, metallisch schwarzer Schaft
- Kultige sechseckige Form
- Nachfüllbares Design
- Langlebig und nachhaltig
- Perfekt für jeden Anlass

IT/

- Elegante corpo nero metallizzato
- Iconica forma esagonale
- Design ricaricabile
- Lunga durata e sostenibilità
- Perfetto per ogni occasione

ES/

- Elegante cuerpo negro metalizado.
- Icónica forma hexagonal.
- Diseño recargable.
- Duradero y sostenible.
- Perfecto para cualquier ocasión.

Engineered for reliability. Proven for 70 years



*Together, we celebrate
70 years of the
BIC® M10® Clic ballpen.*

FR/
Conçu pour être fiable.
Testé pendant 70 ans.
*Ensemble, nous célébrons
les 70 ans du stylo à bille
BIC® M10® Clic.*

DE/
Auf Zuverlässigkeit ausgelegt.
Seit 70 Jahren bewährt.
*Gemeinsam feiern wir das
70-jährige Jubiläum des
Kugelschreibers BIC® M10® Clic.*

IT/
**Progettato per garantire
affidabilità.**
Comprovato da 70 anni
*Festeggiamo insieme i 70 anni
della penna a sfera BIC® M10® Clic.*

ES/
**Diseñado para ofrecer
fiabilidad.**
Testado durante 70 años.
*Celebramos juntos los 70 años
del bolígrafo BIC® M10® Clic.*

NEW!

BIC® M10® Clic Pastel

Vintage, Trendy, Pastel!

MADE IN FRANCE

BIC
GRAPHIC

BIC®
WRITING INSTRUMENTS

OTHER WRITING
INSTRUMENTS

NOTEBOOKS

BIC® / DIEEP® LIGHTERS
AND BIC® CASES

BIC®
PACKAGING

GENERAL
INFORMATION

Designed to make ideas **STAND OUT**



Perfect for creative expression, corporate giveaways, events and educational promotions.

Precise and vibrant, putting your brand in the spotlight

Large flat surface ideal for full-colour digital BritePix™ printing.



WOW!

FR/
Conçu pour mettre les idées en valeur.

Idéal pour l'expression créative, les cadeaux d'entreprise, les événements et les promotions éducatives.

Précis et éclatant, il met votre marque en avant.

Grande surface plane idéale pour l'impression numérique BritePix™ en couleur.

DE/
Entwickelt, um Ideen hervorzuheben.

Perfekt für kreativen Ausdruck, Werbegeschenke, Veranstaltungen und Bildungsaktionen.

Präzise und lebendig, rückt Ihre Marke ins Rampenlicht. Große, flache Oberfläche, ideal für den vollfarbigen Digitaldruck im BritePix™-Verfahren.

IT/
Progettato per mettere in risalto le idee.

Perfetto per l'espressione creativa, gli omaggi aziendali, gli eventi e le promozioni didattiche.

Preciso e vivace, mette in risalto il tuo marchio.

Ampia superficie piana ideale per la stampa digitale BritePix™ a colori.

ES/
Diseñado para que las ideas destaquen.

Perfecto para la expresión creativa, obsequios corporativos, eventos y promociones educativas.

Preciso y vibrante, pon tu marca en el punto de mira.

Gran superficie plana ideal para la impresión digital a todo color BritePix™.



BIC® GRAPHIC

BIC® WRITING INSTRUMENTS

OTHER WRITING INSTRUMENTS

NOTEBOOKS

BIC® / DIEEP® LIGHTERS AND BIC® CASES

BIC® PACKAGING

GENERAL INFORMATION

BIC® WRITING INSTRUMENTS

01

Discover the new generation of the BIC® Cristal® pens.

The **BIC® Cristal® Expression** blends timeless design with vibrant BritePix™ personalisation. The **BIC® Cristal® Re'New™** features a durable matte silver metal barrel with a 96% recycled plastic cap, while the **BIC® Cristal® Re'New™ Black** adds a glossy, sophisticated finish to the iconic **BIC® Cristal® Re'New™**.

FR/

Découvrez la nouvelle génération de stylos BIC® Cristal®.

Le BIC® Cristal® Expression allie un design intemporel à une personnalisation BritePix™ éclatante. Le **BIC® Cristal® Re'New™** se caractérise par un corps métallique argenté mat durable et un capuchon en plastique recyclé à 96 %, tandis que le **BIC® Cristal® Re'New™ Black** ajoute une finition brillante et sophistiquée à l'emblématique **BIC® Cristal® Re'New™**.

DE/

Entdecken Sie die neue Generation der BIC® Cristal®-Stifte.

Der BIC® Cristal® Expression verbindet zeitloses Design mit lebendiger BritePix™-Personalisierung. Der **BIC® Cristal® Re'New™** verfügt über einen robusten, matt silbernen Metallschaft mit einer Kappe aus 96 % recyceltem Kunststoff, während der **BIC® Cristal® Re'New™ Black** dem ikonischen **BIC® Cristal® Re'New™** ein glänzendes, elegantes Finish verleiht.

IT/

Scopri la nuova generazione di penne BIC® Cristal®.

La BIC® Cristal® Expression unisce un design intramontabile alla vivace personalizzazione BritePix™. La **BIC® Cristal® Re'New™** presenta un resistente fusto in metallo argento opaco con un cappuccio in plastica riciclata al 96%, mentre la **BIC® Cristal® Re'New™ Black** aggiunge una finitura lucida e sofisticata all'iconica **BIC® Cristal® Re'New™**.

ES/

Descubre la nueva generación de bolígrafos BIC® Cristal®.

El BIC® Cristal® Expression combina un diseño atemporal con la vibrante personalización BritePix™. El **BIC® Cristal® Re'New™** cuenta con un cuerpo metálico plateado mate resistente y un capuchón de plástico reciclado en un 96 %, mientras que el **BIC® Cristal® Re'New™ Black** añade un acabado brillante y sofisticado al icónico **BIC® Cristal® Re'New™**.

Writes Up to 3km



1095
BIC® Cristal®
Expression



1095
BIC® Cristal®
Expression

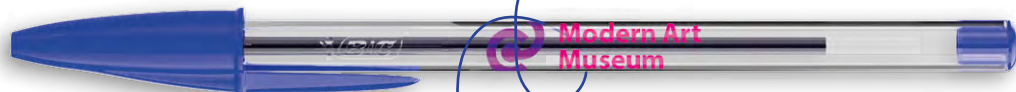

1095
BIC® Cristal®
Expression

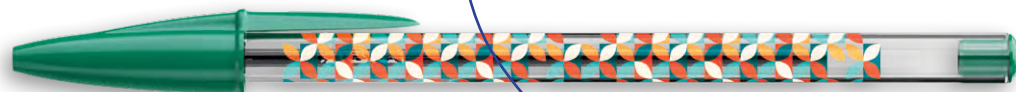

1095
BIC® Cristal®
Expression



1090
BIC® Cristal®
Re'New™



1092
BIC® Cristal®
Re'New™ Black



Iconic object of design.

1095

BIC® CRISTAL®
EXPRESSION

1095

Ink Colour



02

03

05

04

1:1 scale

FR
**Objet emblématique
du design.**

DE
**Legendäres
Designobjekt.**

IT
**Oggetto iconico
di design.**

ES
**Objeto icónico
de diseño.**

1095

BIC® CRISTAL® EXPRESSION

1095

A BP: BritePix™ Digital

MOQ 250 units

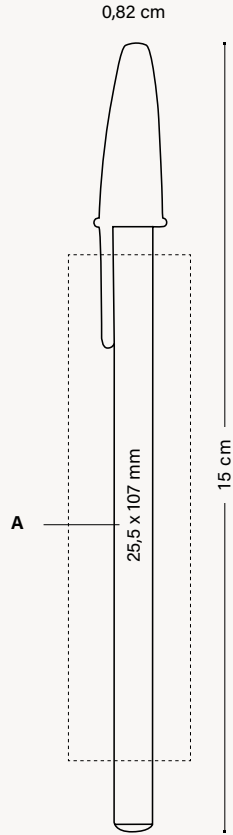

OPTIONAL SPECIAL PACKAGING



BIC® COLLECTION BOX
SLIM PENS 4 UNITS

+ INFO PAGES 254 TO 265

EXTERNAL PACKAGING



500 ± 3,5 KG



WRITING
MODES



PRINTING
TECHNIQUES



BRITEPIX™ DIGITAL

SUSTAINABILITY



CHECK OUT THE VIDEO

See pages 272-276 for a detailed explanation of the icons.

Elegance dressed in metal.

1090

BIC® CRISTAL®
RE'NEW™

1090

Ink Colour



18

18

18

1:1 scale

BIC® WINDOW BOX

1 pen + 2 refills



Your BIC® Cristal® Re'New™
comes with this packaging!

(Included in the price)

FR

L'élégance vêtue
de métal.

DE

Eleganz in Metall
gekleidet.

IT

Eleganza vestita
di metallo.

ES

Elegancia
vestida de metal.

1090

BIC® CRISTAL® RE'NEW™

1090

A LE: max. 1 col.

MOQ 25 units

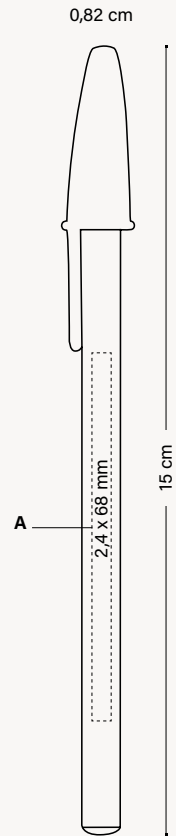

EXTERNAL PACKAGING



44 ± 1KG



WRITING MODES



PRINTING TECHNIQUES



SUSTAINABILITY



BIC GRAPHIC

BIC WRITING INSTRUMENTS

OTHER WRITING INSTRUMENTS

NOTEBOOKS

BIC / D'JEEP LIGHTERS AND BIC CASES

BIC PACKAGING

GENERAL INFORMATION

See pages 272-276 for a detailed explanation of the icons.

Sleek. Elegant. Refillable.

1092

BIC® CRISTAL®
RE'NEW™ BLACK
1092

Ink Colour



NEW!



18



18

BIC® WINDOW BOX

1 pen with black ink + 1 blue refill



*Your BIC® Cristal® Re'New™ Black
comes with this packaging!*

(Included in the price)

FR/
**Élégant. Raffiné.
Rechargeable.**

DE/
**Schlank. Elegant.
Nachfüllbar.**

IT/
**Elegante. Raffinato.
Ricaricabile.**

ES/
**Elegante. Sofisticado.
Recargable.**

BIC® CRISTAL® RE'NEW™ BLACK

1092

BIC® CRISTAL® RE'NEW™ BLACK
1092

A LE: max. 1 col.

MOQ 25 units

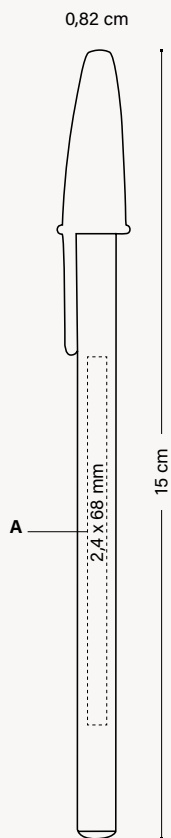

EXTERNAL PACKAGING



WRITING
MODES



PRINTING
TECHNIQUES



SUSTAINABILITY



BIC
GRAPHIC

BIC®
WRITING INSTRUMENTS

OTHER WRITING
INSTRUMENTS

NOTEBOOKS

BIC® / D'JEEP® LIGHTERS
AND BIC® CASES

BIC®
PACKAGING

GENERAL
INFORMATION

See pages 272-276 for a detailed explanation of the icons.

BIC® STYLE

Globally renowned BIC® cap design.

The BIC® Style offers excellent
value for money.

FR/

**Facilement reconnaissable
dans le monde entier grâce à
son capuchon emblématique.**

Le BIC® Style offre un excellent rapport
qualité-prix.

DE/

**Weltweit leicht an der
legendären Kappe zu erkennen.**

Der BIC® Style bietet ein
hervorragendes Preis-Leistungs-
Verhältnis.

IT/

**Riconoscibile facilmente
grazie al suo tappo iconico.**

BIC® Style offre un eccellente
rapporto qualità-prezzo.

ES/

**Reconocido mundialmente
por su icónico capuchón.**

El BIC® Style ofrece una excelente
relación calidad precio.

Simple and recognizable.

A classic Style



1610

BIC® STYLE
1610 Opaque

Ink Colour



01/01

01/03

01/04

01/02

02/02

04

10

1:1 scale

●
Only available
in black ink

●
Only available
in blue ink

●
Only available
in black ink



MANUFACTURED
AND PRINTED IN
BIC FACTORIES



REGULATORY
COMPLIANCE



ISO
certified

WRITING
MODES



BALLPEN M
Ø 1 MM

PRINTING
TECHNIQUES



SCREEN PRINTING

SUSTAINABILITY



IMPRIM'VERT®



100% ELECTRICITY
COMING FROM
RENEWABLE SOURCES

See pages 272-276 for a detailed explanation of the icons.

1610

BIC® STYLE
1610 Clear

Ink Colour



92

87

88

89

8H

93

1:1 scale

1610

BIC® STYLE

1610 Opaque
A SP: max. 1 col.

BIC® STYLE

1610 Clear
B SP: max. 1 col.

MOQ 500 units

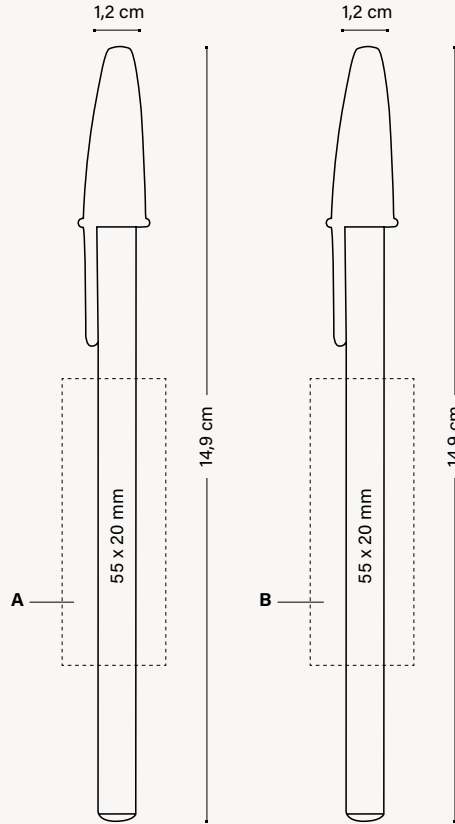

WRITING MODES



PRINTING TECHNIQUES



SUSTAINABILITY



OPTIONAL SPECIAL PACKAGING



PLASTIC POUCH

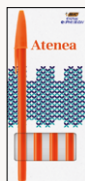

BIC® COLLECTION BOX SLIM PENS 4 UNITS

+ INFO PAGES 254 TO 265

EXTERNAL PACKAGING



500 ± 3,5 KG

Can be used as bookmark

See pages 272-276 for a detailed explanation of the icons.

BIC® ROUND STIC®

The BIC® Round Stic® offers a timeless design, smooth writing and high quality.

FR/
Le BIC® Round Stic® offre un design intemporel, une écriture fluide et une grande qualité.

IT/
La BIC® Round Stic® offre un design senza tempo, una scrittura scorrevole e un'elevata qualità.

DE/
Der BIC® Round Stic® bietet ein zeitloses Design, ein angenehmes Schreibgefühl und hohe Qualität.

ES/
El BIC® Round Stic® ofrece un diseño atemporal, una escritura suave y alta calidad.



Writing made
a pleasure

1010

BIC® ROUND STIC®
1010 Opaque

Ink Colour
● ● ●

Red Ink available under request



*Embossed
iconic BIC® brand!*



*Only available
on white barrel*



PERSONALISED
COLOURS



MANUFACTURED
AND PRINTED IN
BIC FACTORIES



MADE
IN SPAIN



REGULATORY
COMPLIANCE



WRITING
MODES



BALLPEN M
Ø 1 MM

PRINTING
TECHNIQUES



SCREEN PRINTING



DIGITAL

SUSTAINABILITY



100% ELECTRICITY
COMING FROM
RENEWABLE SOURCES

1010

BIC® ROUND STIC®
1010 Frosted

Ink Colour
● ● ●

Red Ink available under request



69

63

71

66

68

67

40

1:1 scale

**Available in selected countries, please ask your customer service representative.*

BIC® ROUND STIC®

ECO version and standard at the same price!



1E10

BIC® ROUND STIC®
1E10 Opaque

Ink Colour
● ● ●

Red Ink available under request



1E/6E 1E/7E 1E/10E

1E10

BIC® ROUND STIC®
1E10 Frosted

Ink Colour
● ● ●

Red Ink available under request



2E/6E 2E/7E 2E/3E 2E/10E

360° Printing

1:1 scale

1:1 scale

Only available on white barrel



MIX & MATCH



PERSONALISED COLOURS



MANUFACTURED AND PRINTED IN BIC FACTORIES



MADE IN SPAIN



REGULATORY COMPLIANCE



ISO certified

WRITING MODES



BALLPEN M Ø 1 MM

PRINTING TECHNIQUES



SP SCREEN PRINTING



DG DIGITAL

SUSTAINABILITY



IMPRIM'VERT®



FRUIT AND VEGETABLE TRAYS



100% ELECTRICITY COMING FROM RENEWABLE SOURCES

BIC GRAPHIC

BIC® WRITING INSTRUMENTS

OTHER WRITING INSTRUMENTS

NOTEBOOKS

BIC® / DIEEP® LIGHTERS AND BIC® CASES

BIC® PACKAGING

GENERAL INFORMATION

See pages 272-276 for a detailed explanation of the icons.

*The percentage is calculated based on total weight of the product excluding ink system. Due to the recycled content of the raw materials used to make the pen, we cannot guarantee that the colours shown in the catalogue or colours customised to order will always have the same colour and appearance.

BIC® ROUND STIC®

1010 / 1E10

BIC® ROUND STIC®

1010 / **ecolutions®** 1E10 Opaque
 1010 / **ecolutions®** 1E10 Frosted

MOQ 500 units.
 Standard colours combination



No extra charge

ecolutions®



Standard colours combination*

Plug

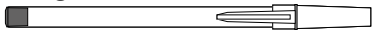

Opaque											Frosted											
	01	12	10	03	05	07	18	02	20	04		69	63	71	66	68	67	40	8E	7E	10E	3E

Cap

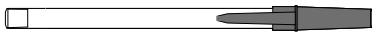

Opaque									Frosted									
	01	12	10	03	05	07	18	02		69	63	66	67	40	8E	7E	10E	3E

Section

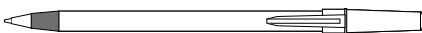

Opaque											Frosted										
	01	12	10	03	05	07	18	02	20	04		69	63	71	66	67	40	8E	7E	10E	3E

Barrel



Opaque								Frosted								Opaque		Frosted	
	01	12	03	05	07	18	02		69	63	71	66	68	67	40	1E		2E	

Exact colour match: ≥ 10.000 units



**Excluding ink system
 Add the Möbius loop to your artwork at no additional charge. Please specify it on your order. (Möbius loop imprint defaults to left-hand corner.)

*Due to the recycled content of the raw materials used to make the product, we cannot guarantee that the colours shown in the catalogue or colours customised to order will always have the same colour and appearance.
 ** The percentage is calculated based on total weight of the product excluding ink system.

1010 / 1E10

BIC® ROUND STIC®

1010

ecolutions® 1E10

A SP: max. 3 col.

B SP: max. 1 col.

C SP: max. 1 col.

D DG: full-colour

(Only available on white barrel)

MOQ 500 units.

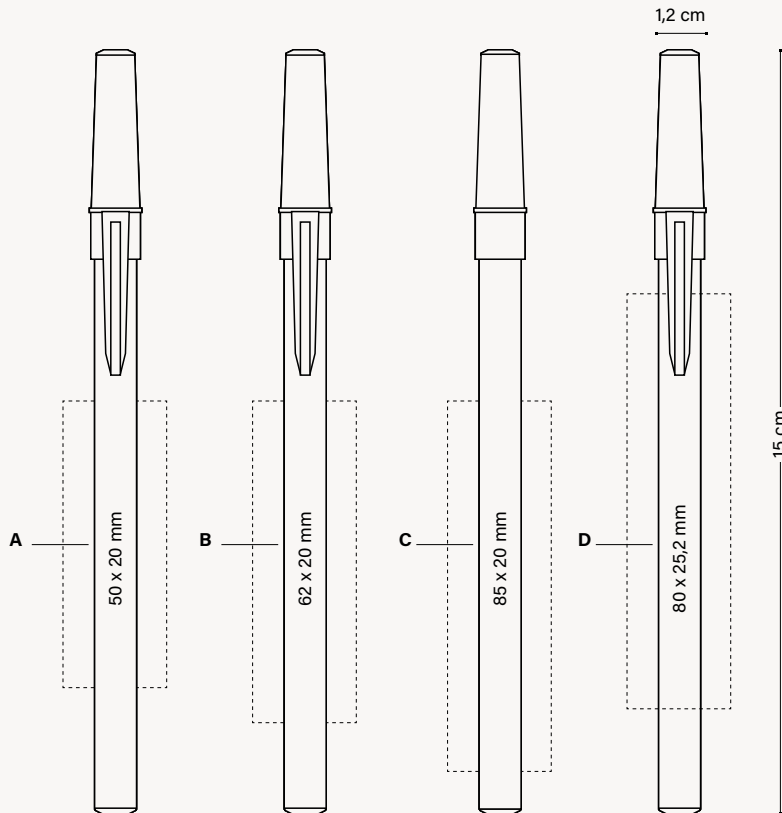

OPTIONAL SPECIAL PACKAGING



PLASTIC
POUCH



BIC® COLLECTION BOX
SLIM PENS 4 UNITS

+ INFO PAGES 254 TO 265

EXTERNAL PACKAGING



500 ± 2,5 KG

Can be used
as bookmark

MIX &
MATCH



PERSONALISED
COLOURS



MANUFACTURED
AND PRINTED IN
BIC FACTORIES



MADE
IN SPAIN



REGULATORY
COMPLIANCE



WRITING
MODES



BALLPEN M
Ø 1 MM

PRINTING
TECHNIQUES



SCREEN PRINTING



DIGITAL

SUSTAINABILITY



IMPRIM'VERT®

ecolutions®



FRUIT AND
VEGETABLE TRAYS



100% ELECTRICITY
COMING FROM
RENEWABLE SOURCES

BIC
GRAPHIC

BIC®
WRITING INSTRUMENTS

OTHER WRITING
INSTRUMENTS

NOTEBOOKS

BIC® / DIIPEE® LIGHTERS
AND BIC® CASES

BIC®
PACKAGING

GENERAL
INFORMATION

See pages 272-276 for a detailed explanation of the icons.

BIC® M10® CLIC

Engineered for reliability. Proven for 70 years



Embossed
iconic BIC®
brand!

1590

BIC® M10® CLIC
1590

Ink Colour
●

NEW!

BIC® M10® CLIC PASTEL

MADE IN FRANCE

Side push
button
→



01 02 04 8G 10 14 59 3D 8D 85 90 84 83

●
Only available
in black ink

1:1 scale

FR/
**Conçu pour
être fiable.**
Testé pendant 70 ans.

DE/
**Auf Zuverlässigkeit
ausgelegt.**
Seit 70 Jahren bewährt.

IT/
**Progettato per
garantire affidabilità.**
Comprovato da 70 anni.

ES/
**Diseñado para
ofrecer fiabilidad.**
Testado durante 70 años.

1590

BIC® M10® CLIC
1590

A SP: max. 2 col.

MOQ 500 units

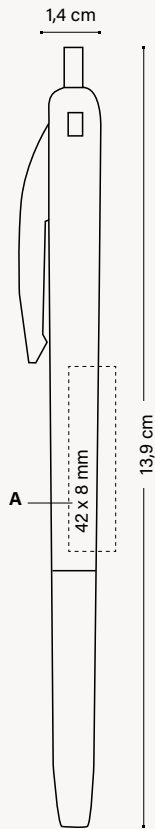

OPTIONAL SPECIAL PACKAGING



+ INFO PAGES 254 TO 265

*Can be used
as bookmark*

EXTERNAL PACKAGING



WRITING MODES



PRINTING TECHNIQUES



SUSTAINABILITY





One of the bestsellers in the industry.

With its functional and widely recognized design, our BIC® Media Clic is a long lasting product available in different materials. Choose between the Standard, Recycled, Biobased, Antibacterial and premium finishes.

Be inspired with the wide range of finishes and colours, and match them to enhance your brand.

FR/

Notre BIC® Media Clic, un best-seller de l'industrie

Au design fonctionnel et largement reconnu, c'est un produit durable disponible dans différents matériaux. Choisissez parmi le Standard, Recyclé, Biobased, Antibactérien et finitions premium.

Laissez-vous inspirer par la vaste gamme de finitions et de couleurs, et associez-les pour mettre en valeur votre marque.

DE/

Einer der Bestseller in der Werbeartikelindustrie.

Funktional und mit hohem Wiedererkennungswert. Unser BIC® Media Clic ist ein langlebiges Produkt, erhältlich in verschiedensten Materialien. Wählen Sie zwischen Standard-, Recycelten-, Biobasierten-, Antibakteriellen- und Premium-Veredelungen.

Lassen Sie sich von einer Vielzahl an Ausführungen und Farben inspirieren und passen Sie ihn optimal an Ihre Marke an.

IT/

Uno dei bestseller del settore.

Dal design funzionale e ampiamente riconosciuto, la nostra BIC® Media Clic è un prodotto di lunga durata disponibile in diversi materiali. Scegli tra i modelli Standard, Riciclato, Biobased, Antibatterico e finiture premium.

Lasciati ispirare dall'ampia gamma di finiture e colori e abbinali per valorizzare il tuo marchio.

ES/

Uno de los más vendidos en la industria.

Con un diseño funcional y ampliamente reconocido, nuestro BIC® Media Clic es un producto duradero disponible en diferentes materiales. Elige entre estándar, reciclado, de material biológico, antibacteriano y acabados premium.

Déjate inspirar por la amplia gama de acabados y colores, y combínalos para realzar tu marca.

BIC® MEDIA CLIC FAMILY



1035
BIC® Media Clic
Advance



1025
BIC® Media Clic
Opaque



1025
BIC® Media Clic
Frosted



1E25
BIC® Media Clic
Ecolutions®



1E29
BIC® Media Clic
Ecolutions® Plus



1020
BIC® Media Clic
Grip Frosted



1E20
BIC® Media Clic
Grip Ecolutions®



1026
BIC® Media Clic BGuard™
Antibacterial



1E26
BIC® Media Clic BGuard™
Antimicrobial Ecolutions®



1972
BIC® Media Clic Biobased
Ecolutions®



1973
BIC® Media Clic Biobased
BGuard™ Antibacterial



1975
BIC® Media Clic Shine



1930
BIC® Media Clic Glacé

BIC®
GRAPHIC

BIC®
WRITING INSTRUMENTS

OTHER WRITING
INSTRUMENTS

NOTEBOOKS

BIC® / DIEEP® LIGHTERS
AND BIC® CASES

BIC®
PACKAGING

GENERAL
INFORMATION

1035

BIC® MEDIA CLIC ADVANCE

1035 Ballpen
Opaque

Ink Colour



NEW!

*Metal
section!*

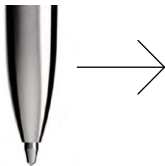

35



01 / 35



03 / 35



07 / 35



06 / 35



02 / 35



**Refill
service on
request**

1:1 scale

BIC® MEDIA CLIC ADVANCE

1035

BIC® MEDIA CLIC ADVANCE

1035 Ballpen

A SP: max. 4 col.

B SP: max. 2 col.

MOQ 500 units.

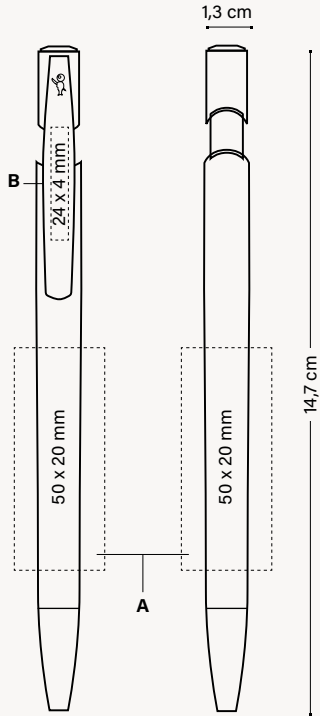

OPTIONAL SPECIAL PACKAGING



ECO SLEEVE

+ INFO PAGES 254 TO 265



PLASTIC POUCH

*Can be used
as bookmark*



WINDOW BOX

EXTERNAL PACKAGING



500 ± 6,5 KG

Plug

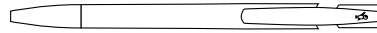

Opaque

01 03 07 06 02

Clip



Opaque

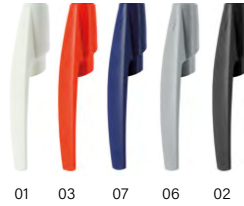

Barrel



Opaque

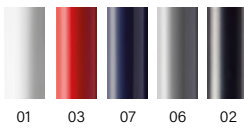

Section



Silver



35



MANUFACTURED
AND PRINTED IN
BIC FACTORIES



MADE
IN SPAIN



REGULATORY
COMPLIANCE



ISO
certified

WRITING
MODES



BALLPEN M
0.1 MM

PRINTING
TECHNIQUES



SCREEN PRINTING

SUSTAINABILITY



IMPRIM'VERT®



100% ELECTRICITY
COMING FROM
RENEWABLE SOURCES

BIC
GRAPHIC

BIC®
WRITING INSTRUMENTS

OTHER WRITING
INSTRUMENTS

NOTEBOOKS

BIC® / DIEEP® LIGHTERS
AND BIC® CASES

BIC®
PACKAGING

GENERAL
INFORMATION

See pages 272-276 for a detailed explanation of the icons.

1025



Embossed
iconic
BIC® brand!



Also in
Mechanical
pencil

BIC® MEDIA CLIC

1025 Ballpen / 1028 Mechanical pencil (see page 172)

Opaque

Ink Colour



Red Ink available under request



12

10

03

5C

2D

05

3D

04

13

07

ECO version and standard at the same price!

ecolutions®



MADE FROM 98% RECYCLED MATERIAL*
*From barrel



PLASTIC CAR PARTS

1E25

BIC® MEDIA CLIC
1E25 Ballpen
Opaque

Ink Colour
● ● ●



360° Printing

1:1 scale

1:1 scale

MIX & MATCH



PERSONALISED COLOURS



MANUFACTURED AND PRINTED IN BIC FACTORIES



MADE IN SPAIN



REGULATORY COMPLIANCE



ISO certified

WRITING MODES



BALLPEN M 0.1 MM

PRINTING TECHNIQUES



SCREEN PRINTING



DIGITAL

SUSTAINABILITY



ecolutions®



PLASTIC CAR PARTS



100% ELECTRICITY COMING FROM RENEWABLE SOURCES

See pages 272-276 for a detailed explanation of the icons.

*The percentage is calculated based on total weight of the barrel. Due to the recycled content of the raw materials used to make the product, we cannot guarantee that the colours shown in the catalogue or colours customised to order will always have the same colour and appearance.

BIC® MEDIA CLIC ECOLUTIONS® PLUS

98% Recycled*

*All external parts are made from 98% recycled material, thanks to the new clip.

Unbreakable clip,
now made from
recycled material.

FR/
98% recyclé*

*Toutes les parties externes sont fabriquées à partir de 98% de matériaux recyclés, grâce au nouveau clip.

DE/
98% recycelt*

*Alle äußeren Teile bestehen zu 98% aus recyceltem Material, dank des neuen Clips.

IT/
Riciclata al 98%*

*Tutte le parti esterne sono realizzate con il 98% di materiale riciclato, grazie alla nuova clip.

ES/
98% reciclado*

*Todas las partes exteriores están fabricadas con un 98 % de material reciclado, gracias al nuevo clip.

98% recycled*



FR/
Clip incassable,
désormais fabriqué à partir
de matériaux recyclés.

DE/
Bruchsicherer Clip, jetzt
aus recyceltem Material
hergestellt.

IT/
Clip infrangibile, ora
realizzata con materiale
riciclato.

ES/
Clip irrompible, ahora
fabricado con material
reciclado.

BIC® MEDIA CLIC ECOLUTIONS® PLUS

ECO version and standard at the same price!

ecolutions®
 **MADE FROM 98% RECYCLED MATERIAL***
 *excl. ink system

PLASTIC CAR PARTS

1E29

BIC® MEDIA CLIC ECOLUTIONS® PLUS

1E29

Opaque

Ink Colour



Red Ink available under request



MIX & MATCH

 MANUFACTURED AND PRINTED IN BIC FACTORIES

 MADE IN SPAIN

 REGULATORY COMPLIANCE

 ISO certified

WRITING MODES

 BALLPEN M
 0.1 MM

PRINTING TECHNIQUES

 SCREEN PRINTING

 DIGITAL

SUSTAINABILITY

 IMPRIM'VEERT®

ecolutions®

 PLASTIC CAR PARTS

 100% ELECTRICITY COMING FROM RENEWABLE SOURCES

BIC GRAPHIC

BIC® WRITING INSTRUMENTS

OTHER WRITING INSTRUMENTS

NOTEBOOKS

BIC® / DIEEP® LIGHTERS AND BIC® CASES

BIC® PACKAGING

GENERAL INFORMATION

*The percentage is calculated based on total weight of the pen excluding ink system. Due to the recycled content of the raw materials used to make the product, we cannot guarantee that the colours shown in the catalogue or colours customised to order will always have the same colour and appearance.

1025

Embossed
iconic
BIC® brand!

Also in
Mechanical
pencil

BIC® MEDIA CLIC

1025 Ballpen / 1028 Mechanical pencil (see page 172)
Frosted

Ink Colour
● ● ●

Red Ink available under request



1020 / 1021

 Embossed
iconic
BIC® brand!

 Also in
Mechanical
pencil

BIC® MEDIA CLIC GRIP

1020 Ballpen

1021 Mechanical pencil (see page 173)

Frosted

Ink Colour



01/69



71/69



82/69



40/69

1:1 scale

**MIX &
MATCH**



PERSONALISED
COLOURS



MANUFACTURED
AND PRINTED IN
BIC FACTORIES



MADE
IN SPAIN



REGULATORY
COMPLIANCE



ISO
certified

WRITING
MODES



BALLPEN M
Ø 1 MM

PRINTING
TECHNIQUES



SCREEN PRINTING



DIGITAL

SUSTAINABILITY



IMPRIM'VERT®



100% ELECTRICITY
COMING FROM
RENEWABLE SOURCES

BIC
GRAPHIC

BIC®
WRITING INSTRUMENTS

OTHER WRITING
INSTRUMENTS

NOTEBOOKS

BIC® / DIEEP® LIGHTERS
AND BIC® CASES

BIC®
PACKAGING

GENERAL
INFORMATION

See pages 272-276 for a detailed explanation of the icons.

MIX & MATCH



PERSONALISED COLOURS



MANUFACTURED AND PRINTED IN BIC FACTORIES



MADE IN SPAIN



REGULATORY COMPLIANCE



WRITING MODES



BALLPEN M 0.1 MM

PRINTING TECHNIQUES



SCREEN PRINTING



DIGITAL

SUSTAINABILITY



IMPRIM'VERT®

ecolutions®



PLASTIC CAR PARTS



100% ELECTRICITY COMING FROM RENEWABLE SOURCES



Embossed iconic BIC® brand!



Also in Mechanical pencil

ECO version and standard at the same price!

ecolutions®



MADE FROM 98% RECYCLED MATERIAL*
*From barrel



PLASTIC CAR PARTS

1E20 / 1E21

BIC® MEDIA CLIC GRIP

1E20 Ballpen

1E21 Mechanical pencil (see page 173)

Opaque

Ink Colour



01/03



01/05



01/02



01/07

1:1 scale

MIX & MATCH No extra charge

MOQ 500 units
ecolutions® Standard colours combination

Plug



Opaque



Frosted



Clip

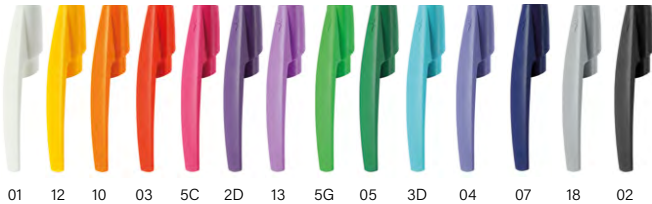

Opaque



Barrel



Opaque

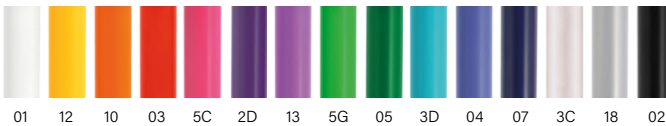

Frosted

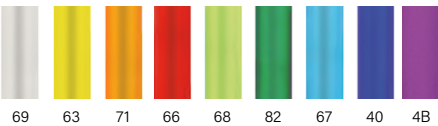

Barrel & Grip

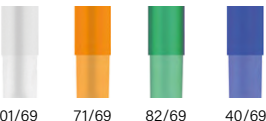

Exact colour match: ≥ 10.000 units 1025/1E25
Exact colour match: ≥ 20.000 units 1020/1E20



ecolutions®



PLASTIC CAR PARTS

Standard colours combination*

Opaque



Barrel & Grip
Opaque



*From barrel

Add the Möbius loop to your artwork at no additional charge. Please specify "Print the Möbius loop" on your order. (Möbius loop imprint defaults to left-hand corner.)

See pages 272-276 for a detailed explanation of the icons.

MIX & MATCH
ecolutions®



PERSONALISED COLOURS



MANUFACTURED AND PRINTED IN BIC FACTORIES

PRINTING TECHNIQUES

SP SCREEN PRINTING

DG DIGITAL

WRITING MODES

BALLPEN M
Ø 1 MM

SUSTAINABILITY

PLASTIC CAR PARTS

BIC® MEDIA CLIC / BIC® MEDIA CLIC GRIP

1025 / 1028 / 1E25 / 1E29

BIC® MEDIA CLIC

1025 Ballpen
 1028 Mechanical pencil (see page 172)
 1E25 Ballpen eColutions®
 1E29 Ballpen eColutions® Plus

A SP: max. 4 col.
B SP: max. 2 col.
C DG: full-colour

MOQ 500 units.

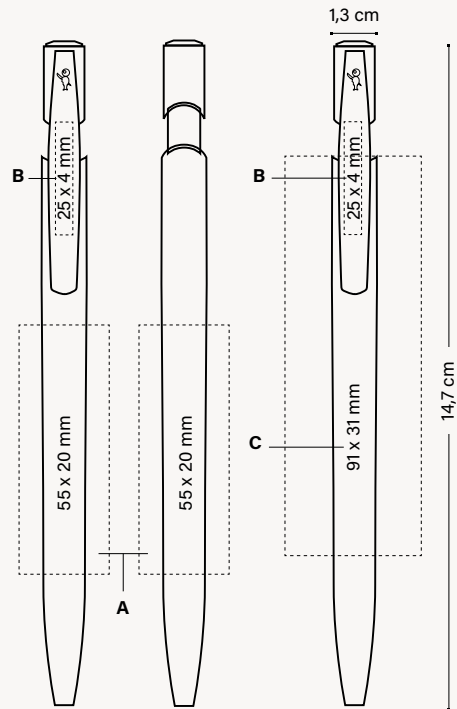

OPTIONAL SPECIAL PACKAGING

EXTERNAL PACKAGING



ECO SLEEVE



PLASTIC POUCH



WINDOW BOX



500 ± 4,1 KG

+ INFO PAGES 254 TO 265

Can be used as bookmark



MANUFACTURED AND PRINTED IN BIC FACTORIES

MADE IN SPAIN

PRINTING TECHNIQUES

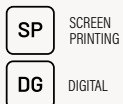

WRITING MODES



SUSTAINABILITY



1020 / 1E20 / 1021 / 1E21

BIC® MEDIA CLIC GRIP

1020 Ballpen
1021 Mechanical pencil
(see page 173)

ecolutions® 1E20 Ballpen
ecolutions® 1E21 Mechanical pencil
(see page 173)

D SP: max. 4 col.

E SP: max. 2 col.

F DG: full-colour

MOQ 500 units.

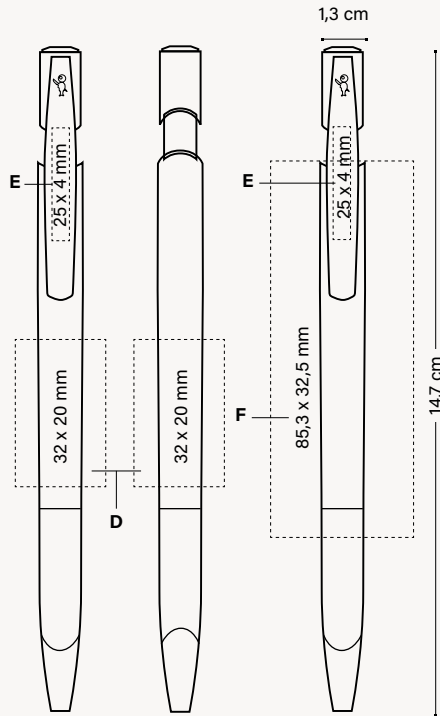

OPTIONAL SPECIAL PACKAGING



ECO SLEEVE

+ INFO PAGES 254 TO 265



PLASTIC POUCH

Can be used
as bookmark



WINDOW BOX



500 ± 4,3 KG

EXTERNAL PACKAGING



MANUFACTURED
AND PRINTED IN
BIC FACTORIES



MADE
IN SPAIN

PRINTING TECHNIQUES

SP SCREEN
PRINTING

DG DIGITAL

WRITING MODES

BALLPEN M
Ø 1 MM

SUSTAINABILITY

PLASTIC
CAR PARTS

BIC® MEDIA CLIC BGUARD™ ANTIBACTERIAL

BGUARD™



Bacteria elimination



Entire pen protection



Timeless protection



Antibacterial Test protocol

1026

BIC® MEDIA CLIC BGUARD™ ANTIBACTERIAL

1026: antibacterial logo
Opaque

Ink Colour



Red Ink available under request



MIX & MATCH

No extra charge

MOQ 500 units
Standard colours combination

Plug



Opaque 1BG 2BG

Clip



Opaque 1BG 2BG

Barrel



Opaque 1BG 2BG

Exact colour match: > 10.000 units



Iconic BIC® Boy and Antibacterial logo always visible!

ANTIBACTERIAL™

BIC® MEDIA CLIC BGUARD™ ANTIBACTERIAL

1026

BIC® MEDIA CLIC BGUARD™ ANTIBACTERIAL

1026: antibacterial logo

A SP: max. 2 col.
B SP: max. 1 col.

MOQ 500 units.

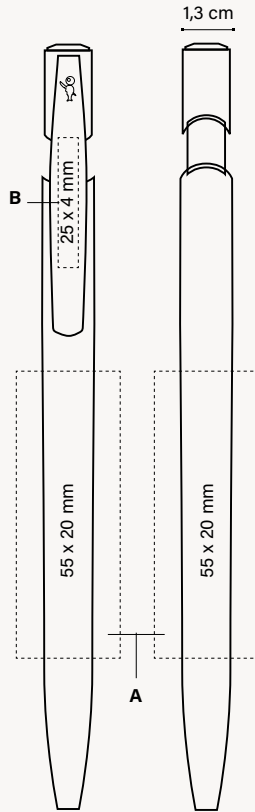

OPTIONAL SPECIAL PACKAGING



ECO SLEEVE

+ INFO PAGES 254 TO 265



PLASTIC POUCH

Can be used as bookmark



WINDOW BOX

EXTERNAL PACKAGING



500 ± 4,1 KG

MIX & MATCH



PERSONALISED COLOURS



MANUFACTURED AND PRINTED IN BIC FACTORIES



MADE IN SPAIN



REGULATORY COMPLIANCE



ISO certified

WRITING MODES



BALLPEN M 0.1 MM

PRINTING TECHNIQUES



SCREEN PRINTING

SUSTAINABILITY



IMPRIM'VERT®



100% ELECTRICITY COMING FROM RENEWABLE SOURCES

BIC GRAPHIC

BIC® WRITING INSTRUMENTS

OTHER WRITING INSTRUMENTS

NOTEBOOKS

BIC® / DLEEP® LIGHTERS AND BIC® CASES

BIC® PACKAGING

GENERAL INFORMATION

See pages 272-276 for a detailed explanation of the icons.

BIC® MEDIA CLIC BGUARD™ ANTIMICROBIAL ECOLUTIONS®



ANTIMICROBIAL™* =



Bacteria elimination
99% in 24h

+



Viral reduction
93% in 24 h

+



Fungal inhibition
for 24 h

BGUARD™

ecolutions®



MADE FROM 98%
RECYCLED MATERIAL**
**From barrel



1E26

BIC® MEDIA CLIC BGUARD™ ANTIMICROBIAL ECOLUTIONS®

ecolutions® 1E26: antimicrobial logo
Opaque

Ink Colour



Red Ink available
under request



MIX & MATCH No extra charge



Add the Möbius loop to your artwork at no additional charge. Please specify it on your order. (Möbius loop imprint defaults to left-hand corner.)

**From barrel

MOQ 500 units
Standard colours combination

Plug



Opaque 1BG 2BG

Clip

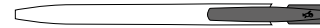

Opaque 1BG 2BG

Barrel



Opaque 1E 3E

Exact colour match: ≥ 10.000 units



*99.9% of bacteria is eliminated from the surface in 24 hours (and more than 30% in 2 hours).
Tested under ISO 22196 protocol adapted to real usage of the pen.

93% of viruses, Sars-Cov-2 Coronavirus causing Covid-19 disease, are eliminated from the surface in 24 hours, (and around 50% in 2 hours).

Tested under ISO 22196 protocol adapted to real usage of the pen.

Fungi present on the surface is inhibited within 24 hours.

Tested under ISO 22196 protocol adapted to fungi and to real usage of the pen.

** The percentage is calculated based on total weight of the barrel. Due to the recycled content of the raw materials used to make the product, we cannot guarantee that the colours shown in the catalogue or colours customised to order will always have the same colour and appearance.

BIC® MEDIA CLIC BGUARD™ ANTIMICROBIAL ECOLUTIONS®



Entire pen protection



Timeless protection



Antibacterial Test protocol



Adapted to fungus test protocol



Antiviral test protocol



PERSONALISED COLOURS



MANUFACTURED AND PRINTED IN BIC FACTORIES



MADE IN SPAIN



REGULATORY COMPLIANCE



WRITING MODES



BALLPEN M 0.1 MM

PRINTING TECHNIQUES



SCREEN PRINTING

SUSTAINABILITY



ecolutions®



PLASTIC CAR PARTS



100% ELECTRICITY COMING FROM RENEWABLE SOURCES

1E26

BIC® MEDIA CLIC BGUARD™ ANTIMICROBIAL ECOLUTIONS®

ecolutions® 1E26: antimicrobial logo

A SP: max. 2 col.

B SP: max. 2 col.

MOQ 500 units.

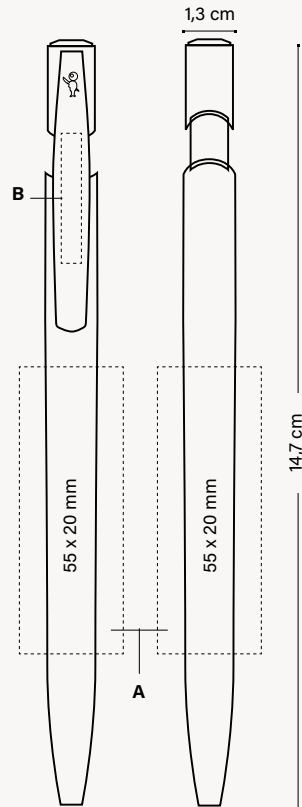

OPTIONAL SPECIAL PACKAGING



ECO SLEEVE

+ INFO PAGES 254 TO 265



PLASTIC POUCH

Can be used as bookmark



WINDOW BOX

EXTERNAL PACKAGING



500 ± 41 KG

BIC GRAPHIC

BIC® WRITING INSTRUMENTS

OTHER WRITING INSTRUMENTS

NOTEBOOKS

BIC® / DIEEP® LIGHTERS AND BIC® CASES

BIC® PACKAGING

GENERAL INFORMATION

See pages 272-276 for a detailed explanation of the icons.



PERSONALISED COLOURS



MANUFACTURED AND PRINTED IN BIC FACTORIES



MADE IN SPAIN



REGULATORY COMPLIANCE



WRITING MODES



BALLPEN M 0.1 MM

PRINTING TECHNIQUES



SCREEN PRINTING



DIGITAL

SUSTAINABILITY



IMPRIM'VERT®



ecolutions®



SUGAR CANE



100% ELECTRICITY COMING FROM RENEWABLE SOURCES

BIOBASED ecolutions®

MADE FROM 69% BIO-SOURCED* MATERIAL

1972

BIC® MEDIA CLIC BIOBASED ECOLUTIONS®

1972 Ballpen
Opaque

Ink Colour
● ● ●

Red Ink available under request



Available on white barrel



* The percentage is calculated based on total weight of the barrel. Due to the natural content of the raw materials used to make the product, we cannot guarantee that the colours shown in the catalogue or colours customised to order will always have the same colour and appearance.

BIC® MEDIA CLIC BIOBASED ECOLUTIONS®



SUGAR CANE

MIX & MATCH No extra charge

MOQ 500 units
Standard colours combination

Plug

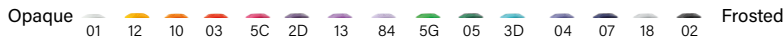

Clip

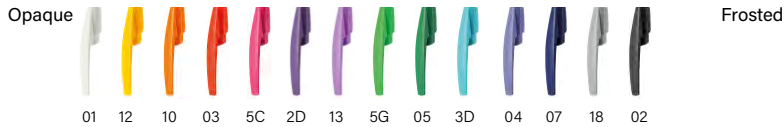

Barrel

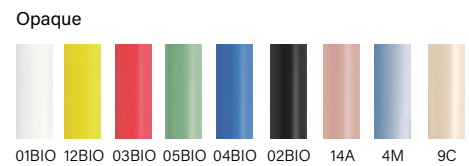

Exact colour match:
≥ 10.000 units

1972

BIC® MEDIA CLIC BIOBASED ECOLUTIONS®

1972

A SP: max. 2 col.
B SP: max. 2 col.
C DG: full-colour

MOQ 500 units.

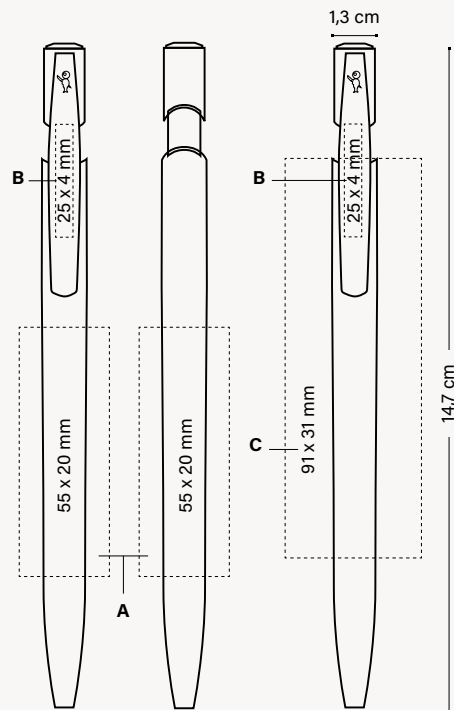

OPTIONAL SPECIAL PACKAGING



+ INFO PAGES 254 TO 265

Can be used as bookmark

EXTERNAL PACKAGING



WRITING MODES



PRINTING TECHNIQUES



SUSTAINABILITY



BIC GRAPHIC

BIC® WRITING INSTRUMENTS

OTHER WRITING INSTRUMENTS

NOTEBOOKS

BIC® / DEEPP® LIGHTERS AND BIC® CASES

BIC® PACKAGING

GENERAL INFORMATION

* Due to the natural content of the raw materials used to make the product, we cannot guarantee that the colours shown in the catalogue or colours customised to order will always have the same colour and appearance.

BIC® MEDIA CLIC BIOBASED BGUARD™ ANTIBACTERIAL

MIX & MATCH



PERSONALISED COLOURS



MANUFACTURED AND PRINTED IN BIC FACTORIES



MADE IN SPAIN



REGULATORY COMPLIANCE



WRITING MODES



BALLPEN M
Ø 1 MM

PRINTING TECHNIQUES



SCREEN PRINTING

SUSTAINABILITY



IMPRIM'VERT®



SUGAR CANE



100% ELECTRICITY COMING FROM RENEWABLE SOURCES

BGUARD™



Bacteria elimination



Entire pen protection



Timeless protection



Antibacterial Test protocol

BIOBASED ecolutions®

MADE FROM
69% **BIO-SOURCED***
MATERIAL

1973

BIC® MEDIA CLIC BIOBASED BGUARD™ ANTIBACTERIAL

1973 Ballpen
Opaque

Ink Colour
● ● ●

Red Ink available under request



02

01

1:1 scale

*The percentage is calculated based on total weight of the barrel. Due to the natural content of the raw materials used to make the product, we cannot guarantee that the colours shown in the catalogue or colours customised to order will always have the same colour and appearance.

BIC® MEDIA CLIC BIOBASED BGUARD™ ANTIBACTERIAL



SUGAR CANE

MIX & MATCH No extra charge

MOQ 500 units. Standard colours combination.

Plug



Opaque

01BG 02BG

Clip



Opaque

01BG 02BG

Barrel



Opaque

01 02

Exact colour match: ≥ 10.000 units



1973

BIC® MEDIA CLIC BIOBASED BGUARD™ ANTIBACTERIAL

1973

A SP: max. 2 col.

B SP: max. 2 col.

MOQ 500 units.

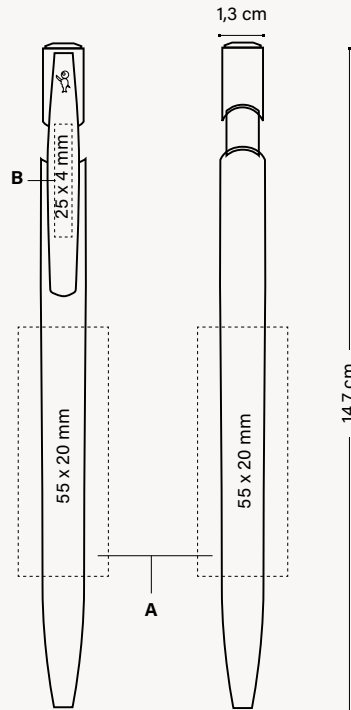

OPTIONAL SPECIAL PACKAGING

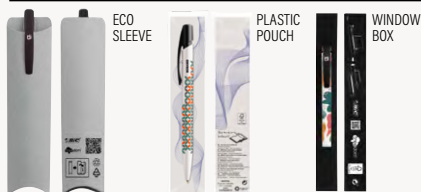

+ INFO PAGES 254 TO 265

Can be used as bookmark

EXTERNAL PACKAGING



PERSONALISED COLOURS



MANUFACTURED AND PRINTED IN BIC FACTORIES



MADE IN SPAIN

WRITING MODES



BALLPEN M
Ø 1 MM

PRINTING TECHNIQUES



SCREEN PRINTING

SUSTAINABILITY



SUGAR CANE

BIC GRAPHIC

BIC® WRITING INSTRUMENTS

OTHER WRITING INSTRUMENTS

NOTEBOOKS

BIC® / BIC® LIGHTERS AND BIC® CASES

BIC® PACKAGING

GENERAL INFORMATION

See pages 272-276 for a detailed explanation of the icons.

*Due to the natural content of the raw materials used to make the product, we cannot guarantee that the colours shown in the catalogue or colours customised to order will always have the same colour and appearance. Available in selected countries, please ask your customer service representative.

1975

BIC® MEDIA CLIC SHINE
1975 Ballpen

Ink Colour
● ● ●

Red Ink available under request



47



26

1:1 scale

MIX & MATCH No extra charge

MOQ 500 units. Standard colours combination.

Plug



Clip

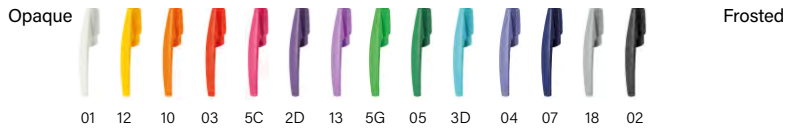

Barrel

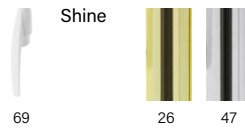

1975

BIC® MEDIA CLIC SHINE

1975

A SP: max. 2 col.

B SP: max. 2 col.

MOQ 500 units.

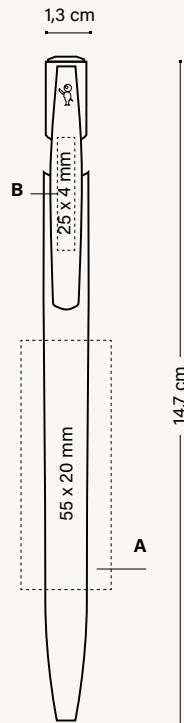

OPTIONAL SPECIAL PACKAGING



+ INFO PAGES 254 TO 265

Can be used as bookmark

EXTERNAL PACKAGING



MIX & MATCH



WRITING MODES



PRINTING TECHNIQUES



SUSTAINABILITY



See pages 272-276 for a detailed explanation of the icons.

BIC® MEDIA CLIC GLACÉ

Our bestseller
in elegant colours.

Elegant
ballpen

1030

BIC® MEDIA CLIC GLACÉ
1030 Glacé

Ink Colour



Red Ink available under request



1:1 scale

FR/

Des couleurs élégantes
pour notre best-seller.

DE/

Elegante Farben für
unseren Bestseller.

IT/

Il nostro best seller
in abito elegante.

ES/

Colores elegantes en
nuestro best seller.

MIX & MATCH No extra charge

MOQ 500 units
Standard colours combination

Plug



Clip

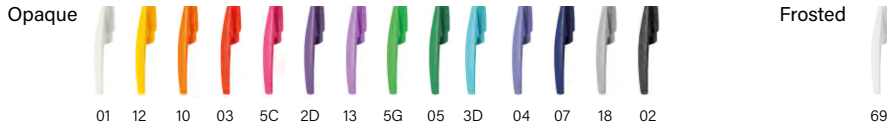

Barrel

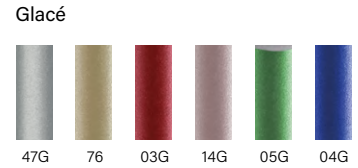

1030

BIC® MEDIA CLIC GLACÉ

1030

A SP: max. 2 col.

B SP: max. 2 col.

MOQ 500 units.

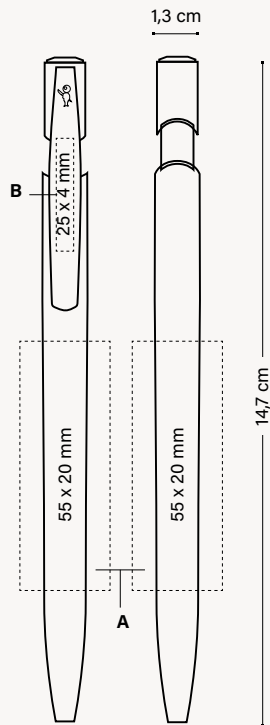

OPTIONAL SPECIAL PACKAGING



+ INFO PAGES 254 TO 265

Can be used
as bookmark

EXTERNAL PACKAGING

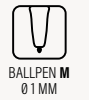

SUSTAINABILITY



See pages 272-276 for a detailed explanation of the icons.

BIC® CLIC STIC

Modern design, practical comfort, reliable performance. That's the BIC® Clic Stic!

FR /
Moderne, pratique, fiable.
Le BIC® Clic Stic est ainsi!

DE /
Modern, praktisch, zuverlässig.
So ist der BIC® Clic Stic!

IT /
Moderna, pratico, affidabile.
Ecco com'è BIC® Clic Stic !

ES /
Moderno, práctico, fiable.
¡Así es BIC® Clic Stic!

→
Multiple colour combinations

Lots of colours
to choose and
versions to assemble

→
Touch tip



BIC® CLIC STIC

ECO version and standard at the same price!

ecolutions®



MADE FROM **87% RECYCLED MATERIAL***
*Excluding ink system

FRUIT AND VEGETABLE TRAYS



MIX & MATCH



PERSONALISED COLOURS



MANUFACTURED AND PRINTED IN BIC FACTORIES



MADE IN SPAIN



REGULATORY COMPLIANCE



WRITING MODES



BALLPEN M 0.1 MM

PRINTING TECHNIQUES



SCREEN PRINTING



DIGITAL

SUSTAINABILITY



IMPRIM'VERT®



FRUIT AND VEGETABLE TRAYS



100% ELECTRICITY COMING FROM RENEWABLE SOURCES

1000

Iconic BIC® Boy is embossed

BIC® CLIC STIC
1000 Opaque

Ink Colour
● ● ●



360° Printing

1:1 scale

12 05 04 07 02 03 01

Available on white barrel



1E00

BIC® CLIC STIC
1E00 Opaque

Ink Colour
● ● ●



360° Printing

1:1 scale

1E/8E 1E/7E 1E/3E 1E/10E 01

Available on white barrel



BIC GRAPHIC

BIC® WRITING INSTRUMENTS

OTHER WRITING INSTRUMENTS

NOTEBOOKS

BIC® / DIEEP® LIGHTERS AND BIC® CASES

BIC® PACKAGING

GENERAL INFORMATION

See pages 272-276 for a detailed explanation of the icons.

*The percentage is calculated based on total weight of the pen excluding ink system. Due to the recycled content of the raw materials used to make the product, we cannot guarantee that the colours shown in the catalogue or colours customised to order will always have the same colour and appearance.

ECO version and standard at the same price!

ecolutions®



MADE FROM **87% RECYCLED MATERIAL***

*Excluding ink system



FRUIT AND VEGETABLE TRAYS

1000

BIC® CLIC STIC
1000 Frosted

Ink Colour
● ● ●

Red Ink available under request



1E00

BIC® CLIC STIC
1E00 Frosted

Ink Colour
● ● ●

Red Ink available under request



*The percentage is calculated based on total weight of the pen excluding ink system. Due to the recycled content of the raw materials used to make the product, we cannot guarantee that the colours shown in the catalogue or colours customised to order will always have the same colour and appearance.

1005

**BIC® CLIC STIC
SOFTFEEL®**
1005 Opaque

Ink Colour
● ● ●

*Red Ink available
under request*



20



07



02

1:1 scale

1005

**BIC® CLIC STIC
SOFTFEEL®**
1005 Frosted

Ink Colour
● ● ●

*Red Ink available
under request*



40

1:1 scale

**MIX &
MATCH**



PERSONALISED
COLOURS



MANUFACTURED
AND PRINTED IN
BIC FACTORIES



MADE IN SPAIN



REGULATORY
COMPLIANCE



**WRITING
MODES**



BALLPEN M
Ø 1 MM

**PRINTING
TECHNIQUES**



SCREEN PRINTING



DIGITAL

SUSTAINABILITY



IMPRIM'VERT®

ecolutions®



FRUIT AND
VEGETABLE TRAYS



100% ELECTRICITY
COMING FROM
RENEWABLE SOURCES

BIC
GRAPHIC

BIC®
WRITING INSTRUMENTS

OTHER WRITING
INSTRUMENTS

NOTEBOOKS

BIC® / DIEEP® LIGHTERS
AND BIC® CASES

BIC®
PACKAGING

GENERAL
INFORMATION

See pages 272-276 for a detailed explanation of the icons.

MIX & MATCH



PERSONALISED COLOURS



MANUFACTURED AND PRINTED IN BIC FACTORIES



MADE IN SPAIN



REGULATORY COMPLIANCE



WRITING MODES



BALLPEN M 0.1 MM

PRINTING TECHNIQUES



SCREEN PRINTING



DIGITAL

SUSTAINABILITY



IMPRIM'VERT®



FRUIT AND VEGETABLE TRAYS



100% ELECTRICITY COMING FROM RENEWABLE SOURCES

ECO version and standard at the same price!

ecolutions®



MADE FROM 87% RECYCLED MATERIAL*

*Excluding ink system



FRUIT AND VEGETABLE TRAYS

1847

BIC® CLIC STIC STYLUS
1847 Opaque

Ink Colour
● ● ●

Red Ink available under request



01

03

04

02

07

1:1 scale

1846

BIC® CLIC STIC STYLUS
1846 Opaque

Ink Colour
● ● ●

Red Ink available under request



1E

3E

1:1 scale

*The percentage is calculated based on total weight of the pen excluding ink system. Due to the recycled content of the raw materials used to make the product, we cannot guarantee that the colours shown in the catalogue or colours customised to order will always have the same colour and appearance.

MOQ 500 units. Standard colours combination

Plug

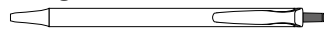

Opaque



Frosted

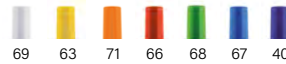

Clip

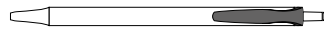

Opaque



Frosted



Section



Opaque



Frosted

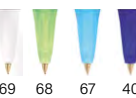

Stylus

Opaque



Barrel



Opaque

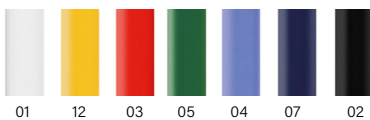

Stylus

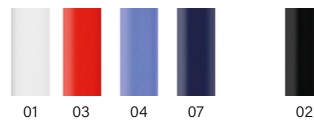

Softfeel®

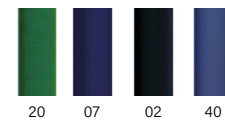

Frosted

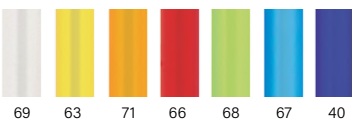

Exact colour match: ≥ 10.000 units

ecolutions®

MOQ 500 units
ecolutions® Standard colours
combination**



*Excluding ink system

Add the Möbius loop to your artwork at no additional charge. Please specify it on your order. (Möbius loop imprint defaults to left-hand corner.)

FRUIT AND
VEGETABLE TRAYS



Plug



Opaque



Section



Opaque



Stylus

Opaque



Clip



Opaque



Barrel



Opaque

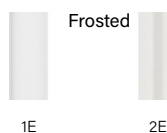

Frosted

Stylus

Opaque



Exact colour match: ≥ 10.000 units

**Due to the recycled content of the raw materials used to make the product, we cannot guarantee that the colours shown in the catalogue or colours customised to order will always have the same colour and appearance.



PERSONALISED COLOURS



MANUFACTURED AND PRINTED IN BIC FACTORIES



MADE IN SPAIN



REGULATORY COMPLIANCE



WRITING MODES



BALLPEN M 0.1 MM

PRINTING TECHNIQUES



SCREEN PRINTING



DIGITAL

SUSTAINABILITY



IMPRIM'VERT®



FRUIT AND VEGETABLE TRAYS



100% ELECTRICITY COMING FROM RENEWABLE SOURCES

1000 / 1E00 / 1847 / 1846

BIC® CLIC STIC

1000 / **ecolutions®** 1E00

BIC® CLIC STIC STYLUS

1847 / **ecolutions®** 1846

A SP: max. 3 col.

B SP: max. 1 col.

C SP: max. 2 col.

D DG: full-colour (area for text)
(Only available on white barrel)

MOQ 500 units.

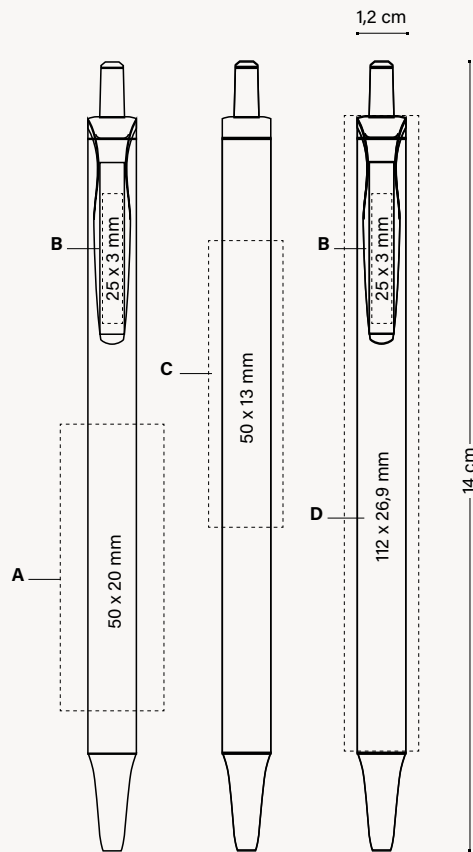

OPTIONAL SPECIAL PACKAGING



ECO SLEEVE

+ INFO PAGES 254 TO 265



PLASTIC POUCH

Can be used as bookmark

EXTERNAL PACKAGING



500 ± 2,9 KG

1005

BIC® CLIC STIC SOFTFEEL®
1005

A/B SP: max. 1 col.

MOQ 500 units.

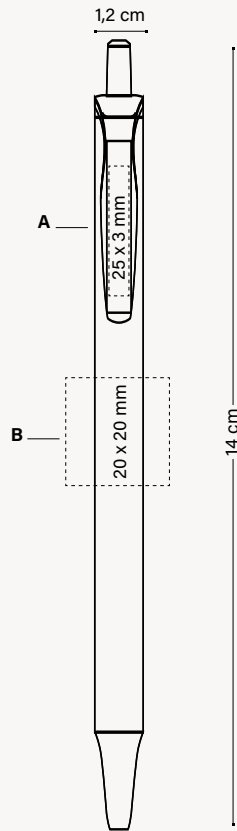

OPTIONAL SPECIAL PACKAGING



ECO SLEEVE



PLASTIC POUCH



BIC® COLLECTION
BOX SLIM PENS
4 UNITS

+ INFO PAGES 254 TO 265

*Can be used
as bookmark*

EXTERNAL PACKAGING



500 ± 2,9 KG

MIX & MATCH



PERSONALISED COLOURS



MANUFACTURED AND PRINTED IN BIC FACTORIES



MADE IN SPAIN



REGULATORY COMPLIANCE



ISO certified

WRITING MODES



BALLPEN M
0.1 MM

PRINTING TECHNIQUES



SCREEN PRINTING



DIGITAL

SUSTAINABILITY



IMPRIM'VERT®



100% ELECTRICITY
COMING FROM
RENEWABLE SOURCES

BIC
GRAPHIC

BIC®
WRITING INSTRUMENTS

OTHER WRITING
INSTRUMENTS

NOTEBOOKS

BIC® / DIEEP® LIGHTERS
AND BIC® CASES

BIC®
PACKAGING

GENERAL
INFORMATION

See pages 272-276 for a detailed explanation of the icons.



Discover the eye-catching clip and its reliable twist mechanism.

Large printing areas offer a wide range of personalisation possibilities in the standard and Advance versions. Also available in Soft and Glacé versions.

In addition, the BIC® Super Clip Origin is a more innovative and sustainable ballpen.

FR/

Découvrez le clip attrayant et son mécanisme pivotant fiable.

La grande zone d'impression XXL offre une vaste gamme de possibilités de personnalisation dans la version Standard et Advance. Également dans les versions Soft et Glacé.

De plus, le BIC® Super Clip Origin est un stylo à bille plus innovant et plus durable.

DE/

Entdecken Sie den auffälligen Clip und seinen zuverlässigen Drehmechanismus.

Der XXL-Druckbereich bietet vielseitige Personalisierungsmöglichkeiten bei der Standard und Advance-Version. Auch als Soft- und Glacé-Version erhältlich.

Darüber hinaus ist der BIC® Super Clip Origin ein innovativerer und nachhaltigerer Kugelschreiber.

IT/

Scopri l'accattivante clip e il suo fluido meccanismo

affidabile. La grande area di stampa XXL offre un'ampia gamma di possibilità di personalizzazione nelle versioni standard e advance. Ora disponibile anche nelle versioni soft e glacé.

Inoltre, la BIC® Super Clip Origin è una penna a sfera più innovativa e sostenibile.

ES/

Descubre el llamativo clip y su mecanismo giratorio fiable.

La gran área de marcaje XXL ofrece una amplia variedad de posibilidades de personalización en la versión estándar y advance. Ahora también en las versiones soft y glacé.

Además, el BIC® Super Clip Origin es un bolígrafo más innovador y sostenible.



1E50
BIC® Super Clip Ecolutions®



1039
BIC® Super Clip



1073
BIC® Super Clip Advance



1082
BIC® Super Clip Glacé

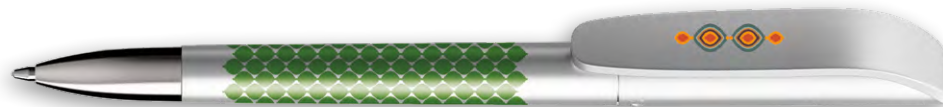

1084
BIC® Super Clip Glacé Advance



1083
BIC® Super Clip Soft



1085
BIC® Super Clip Soft Advance



1038
BIC® Super Clip Origin

A large clip to personalise

1039

BIC® SUPER CLIP
1039 Opaque

Ink Colour
● ●



Large
printing
areas!



Reliable twist
mechanism!

360°
Printing

Available on
white barrel



BIC® SUPER CLIP

ECO version and standard at the same price!

ecolutions®



MADE FROM **90% RECYCLED MATERIAL***
*Excluding ink system



PLASTIC CAR PARTS

1E50

BIC® SUPER CLIP
1E50 Opaque

Ink Colour



1E

171 scale

1039

BIC® SUPER CLIP
1039 Clear

Ink Colour



51

87

86

89



88

171 scale

MIX & MATCH



PERSONALISED COLOURS



MANUFACTURED AND PRINTED IN BIC FACTORIES



MADE IN SPAIN



REGULATORY COMPLIANCE



ISO certified

WRITING MODES



BALLPEN M 0.1 MM

PRINTING TECHNIQUES



SCREEN PRINTING



DIGITAL



BRITEPIX™

BRITEPIX™ TEXTURE
BRITEPIX™ PERSONALISATION

SUSTAINABILITY



ecolutions®



PLASTIC CAR PARTS



100% ELECTRICITY COMING FROM RENEWABLE SOURCES

BIC® GRAPHIC

BIC® WRITING INSTRUMENTS

OTHER WRITING INSTRUMENTS

NOTEBOOKS

BIC® / DIEEP® LIGHTERS AND BIC® CASES

BIC® PACKAGING

GENERAL INFORMATION

*The percentage is calculated based on total weight of the pen excluding ink system. Due to the recycled content of the raw materials used to make the product, we cannot guarantee that the colours shown in the catalogue or colours customised to order will always have the same colour and appearance.

BIC® SUPER CLIP

1039 / 1E50

BIC® SUPER CLIP

1039 Opaque

ecolutions® 1E50 Opaque

1039 Clear

MOQ 250 units

Standard colours combination

MIX & MATCH No extra charge

Clip



Opaque

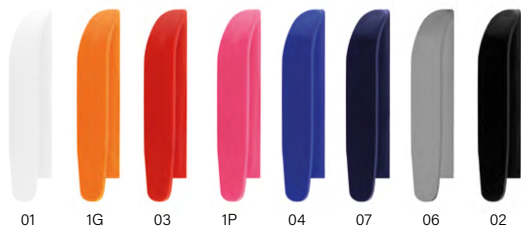

Clear

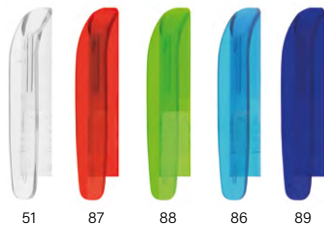

ecolutions®



Standard colours combination*



*Excluding ink system

Add the Möbius loop to your artwork at no additional charge. Please specify it on your order. (Möbius loop imprint defaults to left-hand hand corner.)

Barrel



Opaque

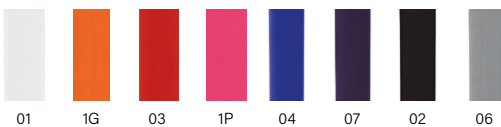

Clear

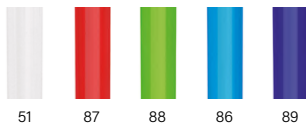

Exact colour match: ≥ 10.000 units



BIC® SUPER CLIP

1039 / 1E50

BIC® SUPER CLIP

1039

ecolutions® 1E50

A SP: max. 2 col.

B SP: max. 1 col.

C DG: full-colour

D BP: full-colour

BP Texture: full-colour

MOQ 250 units.

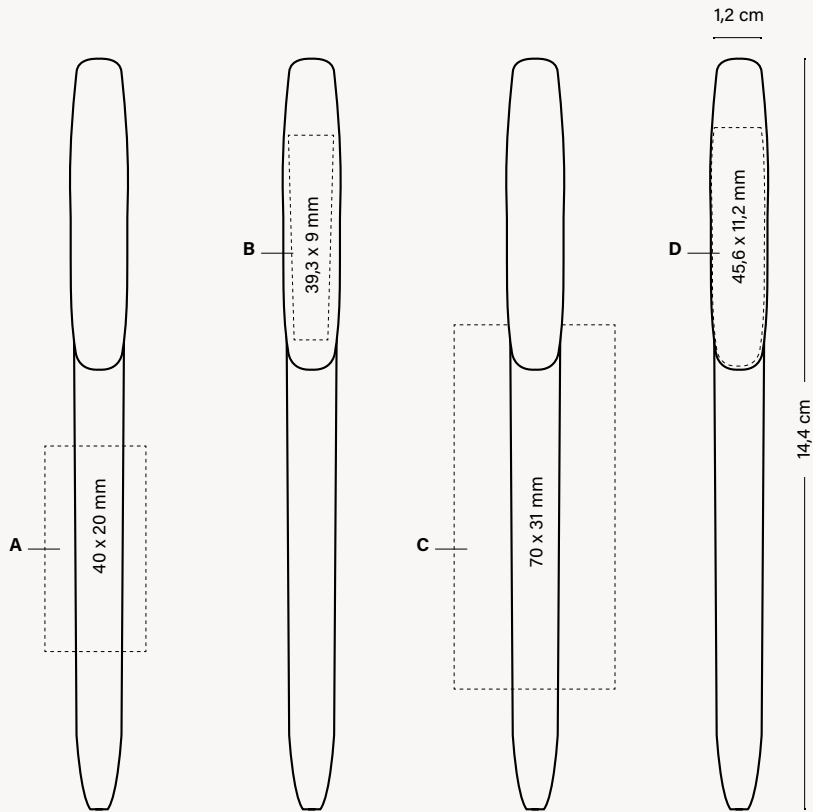

OPTIONAL SPECIAL PACKAGING



+ INFO PAGES 254 TO 265

Can be used as bookmark

(1, 2 & 3 units)

EXTERNAL PACKAGING



250 ± 2,6 KG



WRITING MODES



PRINTING TECHNIQUES



BRITEPIX™ TEXTURE
BRITEPIX™ PERSONALISATION

SUSTAINABILITY



ecolutions®



BIC GRAPHIC

BIC® WRITING INSTRUMENTS

OTHER WRITING INSTRUMENTS

NOTEBOOKS

BIC® / BIC® LIGHTERS AND BIC® CASES

BIC® PACKAGING

GENERAL INFORMATION

See pages 272-276 for a detailed explanation of the icons.

1073

BIC® SUPER CLIP ADVANCE
1073 Opaque

Ink Colour
● ●



BIC® SUPER CLIP ADVANCE



Available on white barrel



MIX & MATCH



WRITING MODES



PRINTING TECHNIQUES



SUSTAINABILITY



BIC GRAPHIC

BIC® WRITING INSTRUMENTS

OTHER WRITING INSTRUMENTS

NOTEBOOKS

BIC® / BIC® LIGHTERS AND BIC® CASES

BIC® PACKAGING

GENERAL INFORMATION

See pages 272-276 for a detailed explanation of the icons.

BIC® SUPER CLIP ADVANCE

1073

BIC® SUPER CLIP ADVANCE
1073 Opaque

MOQ 250 units
Standard colours combination

MIX & MATCH No extra charge

Clip

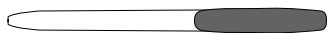

Opaque



Barrel



Opaque

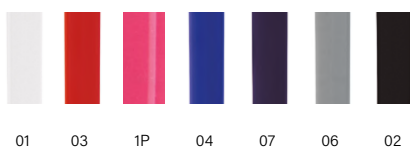

Section

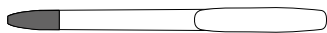

ADVANCE



Exact colour match: $\geq 10,000$ units



BIC® SUPER CLIP ADVANCE

1073

BIC® SUPER CLIP ADVANCE

1073

- A SP:** max. 2 col.
- B SP:** max. 1 col.
- C DG:** full-colour
- D BP:** full-colour
- BP Texture:** full-colour

MOQ 250 units.

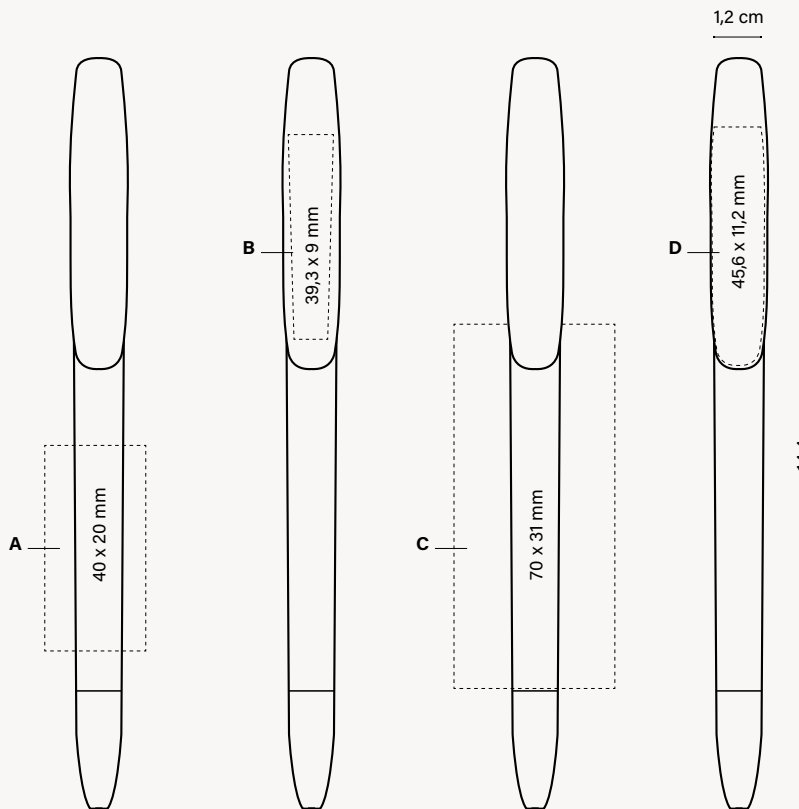

OPTIONAL SPECIAL PACKAGING



+ INFO PAGES 254 TO 265

Can be used as bookmark

(1, 2 & 3 units)

EXTERNAL PACKAGING



250 ± 2,6 KG



PERSONALISED COLOURS



MANUFACTURED AND PRINTED IN BIC FACTORIES



MADE IN SPAIN



REGULATORY COMPLIANCE



ISO certified

WRITING MODES



BALLPEN M
Ø 1 MM

PRINTING TECHNIQUES



SCREEN PRINTING



DIGITAL



BRITEPIX™
BRITEPIX™ TEXTURE
BRITEPIX™ PERSONALISATION

SUSTAINABILITY



IMPRIM'VERT®



100% ELECTRICITY COMING FROM RENEWABLE SOURCES

See pages 272-276 for a detailed explanation of the icons.

BIC GRAPHIC

BIC® WRITING INSTRUMENTS

OTHER WRITING INSTRUMENTS

NOTEBOOKS

BIC® / DLEEP® LIGHTERS AND BIC® CASES

BIC® PACKAGING

GENERAL INFORMATION

BIC® SUPER CLIP GLACÉ

Discover the BIC® Super Clip in a glamorous version.

1082

BIC® SUPER CLIP GLACÉ
1082

Ink Colour
● ●



47G

76

14G

03G

04G

05G

1:1 scale

1084

BIC® SUPER CLIP GLACÉ ADVANCE
1084

Ink Colour
● ●



47G/35

05G/35

14G/35

03G/35

04G/35

76/35

1:1 scale

Refill
service on
request

FR /
Découvrez le
BIC® Super Clip
dans sa version
glamour.

DE /
Entdecken Sie den
BIC® Super Clip in
der glamourösen
Version.

IT /
Scopri la
BIC® Super Clip
nella sua versione più
glamour.

ES /
Descubre el
BIC® Super Clip en
su versión
más glamurosa.

Section

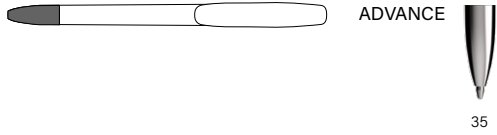

1082 / 1084

BIC® SUPER CLIP GLACÉ
1082

BIC® SUPER CLIP GLACÉ
ADVANCE
1084

A SP: max. 1 col.
B SP: max. 1 col.

MOQ 250 units
Standard colours combination

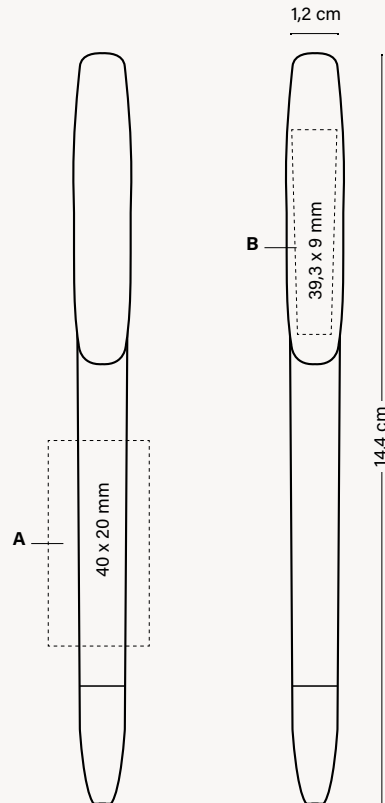

OPTIONAL SPECIAL PACKAGING



+ INFO PAGES 254 TO 265

*Can be used
as bookmark*

(1, 2 & 3 units)

EXTERNAL PACKAGING



PERSONALISED
COLOURS



MANUFACTURED
AND PRINTED IN
BIC FACTORIES



MADE
IN SPAIN



REGULATORY
COMPLIANCE



ISO
certified

WRITING
MODES



BALLPEN M
0.1 MM

PRINTING
TECHNIQUES



SCREEN PRINTING

SUSTAINABILITY



IMPRIM'VERT®



100% ELECTRICITY
COMING FROM
RENEWABLE SOURCES



CHECK OUT THE VIDEO

BIC
GRAPHIC

BIC®
WRITING INSTRUMENTS

OTHER WRITING
INSTRUMENTS

NOTEBOOKS

BIC® / DIEEP® LIGHTERS
AND BIC® CASES

BIC®
PACKAGING

GENERAL
INFORMATION

See pages 272-276 for a detailed explanation of the icons.

BIC® SUPER CLIP SOFT & ADVANCE

Feel the incredible softness of our BIC® Super Clip.



1083

BIC® SUPER CLIP SOFT
1083

Ink Colour



1085

BIC® SUPER CLIP SOFT
ADVANCE
1085

Ink Colour



1:1 scale



1:1 scale



Refill
service on
request

FR /
Découvrez
l'incroyable toucher
soyeux de notre
BIC® Super Clip.

DE /
Sie werden den
unglaublichen
Seidentouch unseres
BIC® Super Clip zu
schätzen wissen.

IT /
Apprezza l'incredibile
sensazione di setosità
della BIC® Super Clip.

ES /
Aprecia el increíble
tacto de seda de
nuestro BIC® Super Clip.

Section

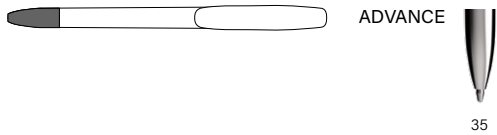

1083 / 1085

BIC® SUPER CLIP SOFT
1083

**BIC® SUPER CLIP SOFT
ADVANCE**
1085

A SP: max. 1 col.

MOQ 250 units
Standard colours combination

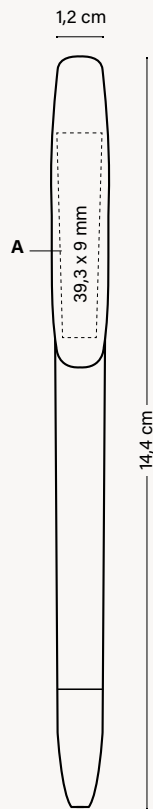

OPTIONAL SPECIAL PACKAGING



+ INFO PAGES 254 TO 265

*Can be used
as bookmark*

(1, 2 & 3 units)

EXTERNAL PACKAGING



250 ± 2,6 KG



**WRITING
MODES**



**PRINTING
TECHNIQUES**



SUSTAINABILITY



BIC
GRAPHIC

BIC®
WRITING INSTRUMENTS

OTHER WRITING
INSTRUMENTS

NOTEBOOKS

BIC® / DIBEE® LIGHTERS
AND BIC® CASES

BIC®
PACKAGING

GENERAL
INFORMATION

See pages 272-276 for a detailed explanation of the icons.

BIC® SUPER CLIP ORIGIN

BIC® Super Clip Origin is made from natural ingredients*.

ORIGIN BIOBASED

FR/

Le BIC® Super Clip Origin est fabriqué à partir de matériaux biosourcés composés de polymères naturels, à l'exclusion d'éléments provenant du pétrole et de combustibles fossiles*.

Fabriqué avec de l'huile de ricin et d'autres ingrédients d'origine végétale.*

Fabriqué et imprimé dans des usines alimentées avec **100% d'électricité d'énergie renouvelable.**

***Corps et clip 100 % biosourcés.**

DE /

BIC® Super Clip Origin besteht aus biobasiertem Material, das mit natürlichen Polymeren und ohne Erdöl oder fossile Brennstoffe hergestellt wird*.

Hergestellt mit **Rilsanöl** und anderen Materialien pflanzlichen Ursprungs.*

Hergestellt und bedruckt in Fabriken, die zu **100 % mit Strom aus erneuerbaren Quellen** betrieben werden.

***Schaft und Clip sind zu 100 % biologischen Ursprungs.**

IT /

BIC® Super Clip Origin è realizzata in materiale biobased prodotto con ingredienti naturali, nessuno dei quali deriva da petrolio o combustibili fossili*.

Realizzata con olio di ricino e altri ingredienti di origine vegetale.*

Prodotto e stampato in stabilimenti alimentati al **100% da energia elettrica rinnovabile.**

***Il fusto e la clip sono al 100% di origine biologica.**

ES/

BIC® Super Clip Origin está hecho de material biológico fabricado con polímeros naturales que excluyen cualquier fuente de petróleo o combustibles fósiles*.

Elaborado con aceite Rilsan y otros ingredientes de origen vegetal.*

Fabricado e impreso en fábricas alimentadas con **electricidad 100% renovable.**

***El cuerpo y el clip son 100 % de origen de material biológico.**

BIC® Super Clip Origin is made from biobased material manufactured with natural polymers excluding any source of petroleum or fossil fuels*.



Made with castor oil and other ingredients of vegetal origin.*



Manufactured and printed in factories 100% powered by **electricity produced using renewable sources.**



Barrel and clip are 100% biosourced.

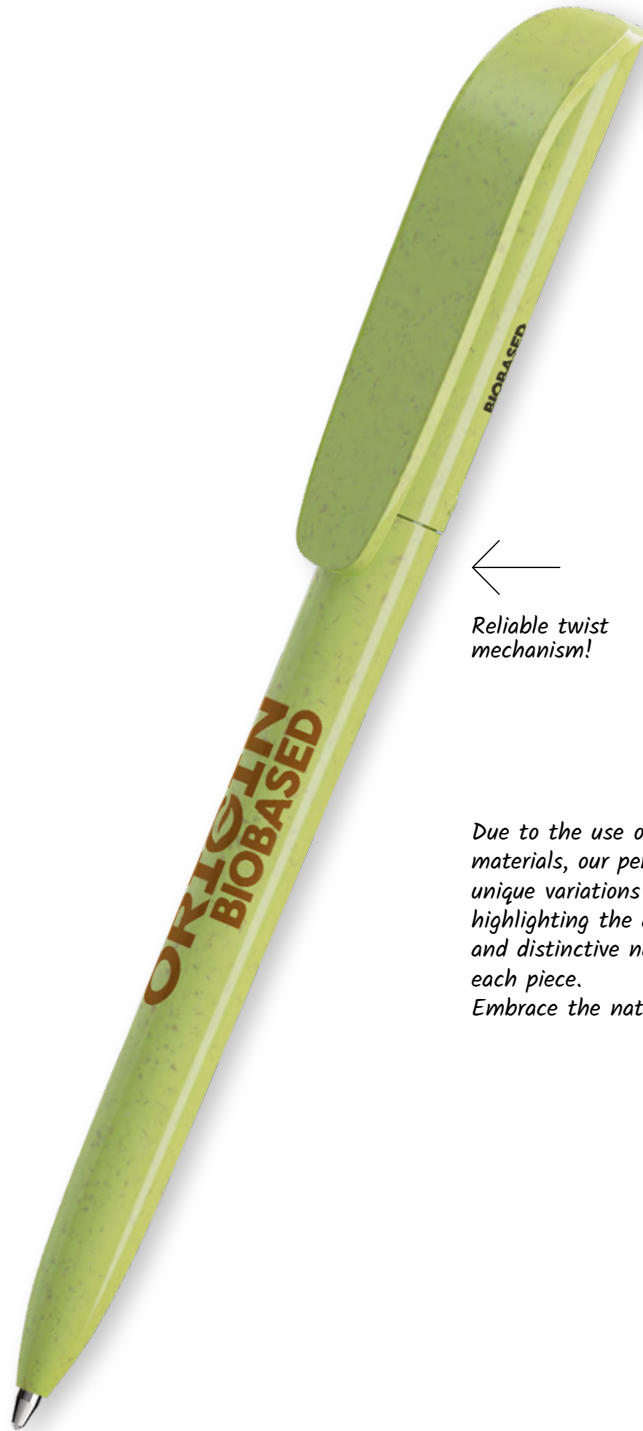

Reliable twist mechanism!

*Due to the use of natural materials, our pens feature unique variations in color, highlighting the authentic and distinctive nature of each piece.
Embrace the natural charm!*

6CO

* Refers to barrel and clip.

ORIGIN BIOBASED

1038

BIC® SUPER CLIP ORIGIN

1038 Opaque

Ink Colour



Barrel and clip are made of 100% biobased materials.

FR/ Corps et clip sont fabriqués à partir de matériaux 100 % biosourcés.

DE/ Schaft und Clip bestehen zu 100 % aus biobasierten Materialien.

IT/ Il fusto e la clip sono realizzati con materiali biologici al 100 %.

ES/ El cuerpo y el clip están fabricados con materiales 100 % biológicos.

*Due to the biobased content of the raw materials used to make the product, we cannot guarantee that the colours shown in the catalogue or colours customised to order will always have the same colour and appearance. * Refers to barrel and clip.*

BIC® SUPER CLIP ORIGIN

1038

BIC® SUPER CLIP ORIGIN

1038

A SP: max. 1 col.

MOQ 250 units
Standard colours combination

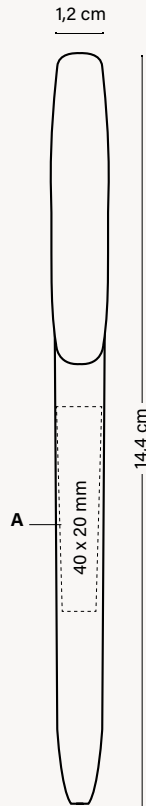

OPTIONAL SPECIAL PACKAGING



EXTERNAL PACKAGING



WRITING MODES



PRINTING TECHNIQUES



SUSTAINABILITY



ORIGIN
BIOBASED



100% ELECTRICITY
COMING FROM
RENEWABLE SOURCES



CHECK OUT THE VIDEO

See pages 272-276 for a detailed explanation of the icons.

BIC GRAPHIC

BIC® WRITING INSTRUMENTS

OTHER WRITING INSTRUMENTS

NOTEBOOKS

BIC® / DIIPEE® LIGHTERS AND BIC® CASES

BIC® PACKAGING

GENERAL INFORMATION

BIC® WIDE BODY™

The right size to show the true value of your brand!

Wide profile and wide variety of possibilities to maximise your message.

FR /

La taille idéale pour mettre en valeur votre marque !

Corps large et multiples possibilités pour optimiser votre communication.

DE /

Die richtige Größe, um den Wert Ihrer Marke widerzuspiegeln!

Breites Profil und eine Vielzahl von Möglichkeiten, Ihre Botschaft klar zu vermitteln.

IT /

La giusta misura per mostrare il vero valore del tuo marchio!

Ampio profilo e vasta gamma di possibilità per ottimizzare il tuo messaggio.

ES /

¡El tamaño ideal para enseñar el valor real de tu marca!

De perfil ancho y gran variedad de posibilidades para maximizar tu mensaje.

Perfect for your big ideas

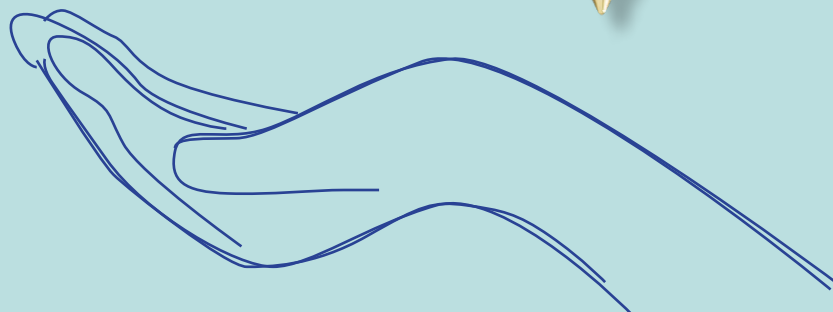

1080

BIC® WIDE BODY™
1080 Opaque

Ink Colour
● ● ●

Red Ink available under request

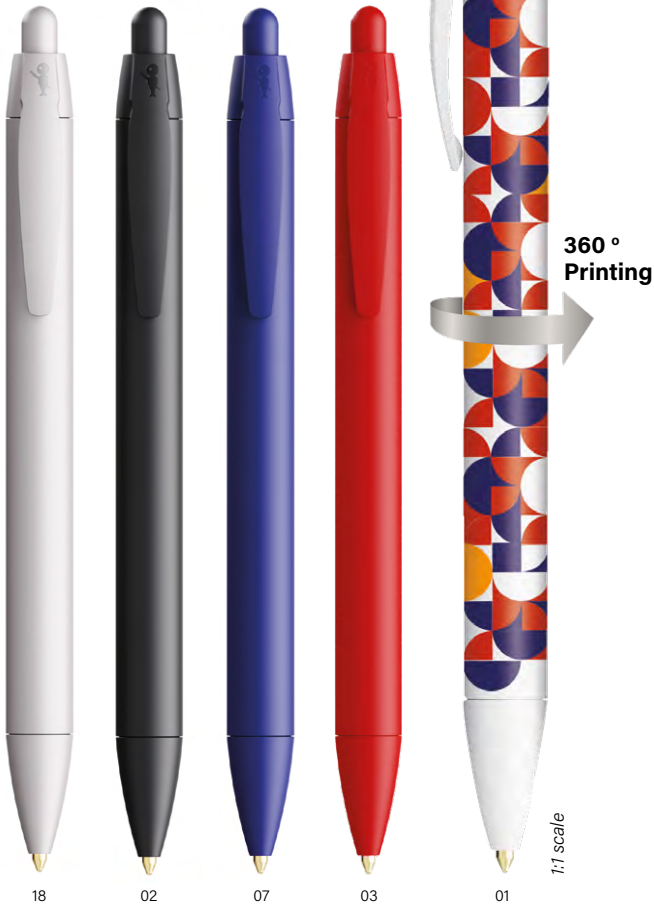

Available on
white barrel



Iconic BIC® Boy
is embossed

ECO version and
standard at the same price!

ecolutions®



MADE FROM **98%**
RECYCLED MATERIAL*
*From barrel



FRUIT AND
VEGETABLE TRAYS

1E80

BIC® WIDE BODY™
ecolutions® 1E80 Opaque

Ink Colour
● ● ●

Red Ink available
under request

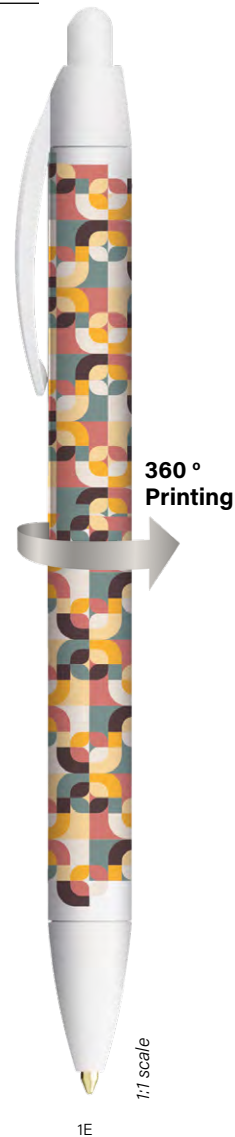

Available on
white barrel



**MIX&
MATCH**



PERSONALISED
COLOURS



MANUFACTURED
AND PRINTED IN
BIC FACTORIES



MADE IN SPAIN



REGULATORY
COMPLIANCE



ISO
certified

**WRITING
MODES**



BALLPEN M
Ø 1 MM

**PRINTING
TECHNIQUES**



SCREEN PRINTING



DIGITAL

SUSTAINABILITY



IMPRIM'VERT®

ecolutions®



FRUIT AND
VEGETABLE TRAYS



100% ELECTRICITY
COMING FROM
RENEWABLE SOURCES

BIC
GRAPHIC

BIC®
WRITING INSTRUMENTS

OTHER WRITING
INSTRUMENTS

NOTEBOOKS

BIC® / DIEEP® LIGHTERS
AND BIC® CASES

BIC®
PACKAGING

GENERAL
INFORMATION

*The percentage is calculated based on total weight of the barrel. Due to the recycled content of the raw materials used to make the product, we cannot guarantee that the colours shown in the catalogue or colours customised to order will always have the same colour and appearance.

1080

BIC® WIDE BODY™
1080 Frosted

Ink Colour
● ● ●

Red Ink available under request



63 66 68 40 71 69 67

1:1 scale

1893

BIC® WIDE BODY™
MINI DIGITAL

1893 Opaque

Ink Colour
● ● ●

Red Ink available under request



01

*Available on
white barrel*



1080 / 1E80 / 1893

MOQ 250 units
Standard colours combination

MIX & MATCH No extra charge

Plug

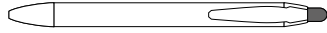

Opaque

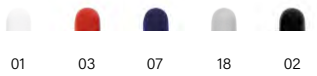

Frosted

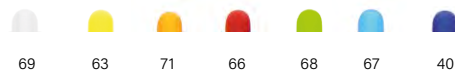

Clip

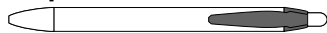

Opaque

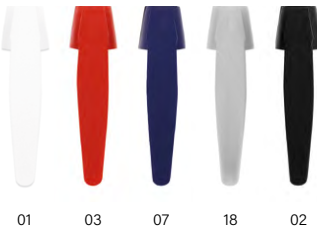

Frosted

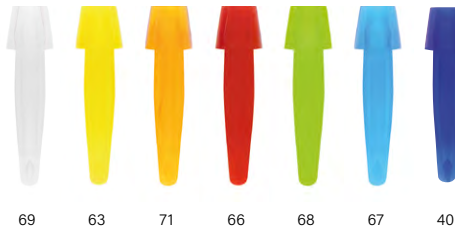

Barrel



Opaque

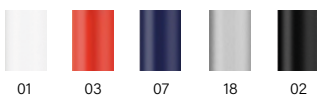

Frosted

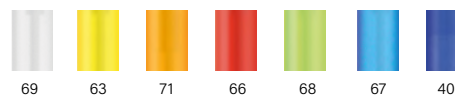

Opaque



ecolutions®*



Add the Möbius loop to your artwork at no additional charge. Please specify "Print the Möbius loop" on your order. (Möbius loop imprint defaults to left-hand corner.)

*From barrel



FRUIT AND VEGETABLE TRAYS

Section



Opaque



Frosted



Exact colour match: ≥ 10.000 units



MIX & MATCH



PERSONALISED COLOURS



MANUFACTURED AND PRINTED IN BIC FACTORIES



MADE IN SPAIN



REGULATORY COMPLIANCE



WRITING MODES



BALLPEN M
Ø 1 MM

PRINTING TECHNIQUES



SCREEN PRINTING



DIGITAL

SUSTAINABILITY



ecolutions®



100% ELECTRICITY COMING FROM RENEWABLE SOURCES



FRUIT AND VEGETABLE TRAYS

*Due to the recycled content of the raw materials used to make the product, we cannot guarantee that the colours shown in the catalogue or colours customised to order will always have the same colour and appearance.

1080 / 1E80

BIC® WIDE BODY™

1080 Opaque

eColutions® 1E80

A/C SP: max. 2 col.

B/E SP: max. 1 col.

D DG: full-colour

MOQ 250 units (SP)

MOQ 500 units (DG)

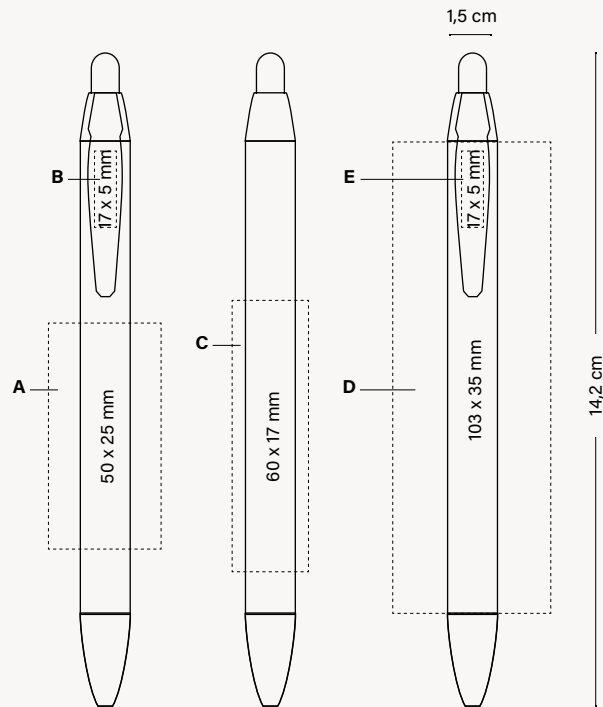

OPTIONAL SPECIAL PACKAGING



ECO SLEEVE

+ INFO PAGES 254 TO 265



PLASTIC POUCH

Can be used as bookmark



WINDOW BOX



BIC® COLLECTION BOX

(1, 2 & 3 units)

EXTERNAL PACKAGING



250 ± 2,6KG

1893

**BIC® WIDE BODY™
MINI DIGITAL**

1893

A DG: full-colour

MOQ 500 units (DG)

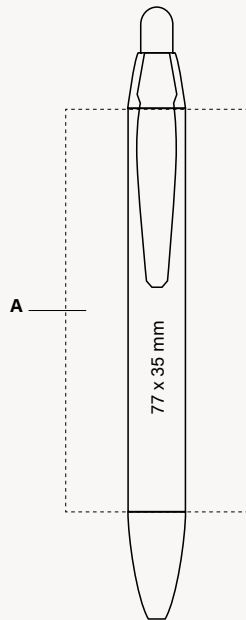

OPTIONAL SPECIAL PACKAGING



+ INFO PAGES 254 TO 265

*Can be used
as bookmark*

(1, 2 & 3 units)

EXTERNAL PACKAGING



PERSONALISED
COLOURS



MANUFACTURED
AND PRINTED IN
BIC FACTORIES



MADE IN SPAIN



REGULATORY
COMPLIANCE



**WRITING
MODES**



BALLPEN M
Ø 1 MM

**PRINTING
TECHNIQUES**



SCREEN PRINTING



DIGITAL

SUSTAINABILITY



ecolutions®



100% ELECTRICITY
COMING FROM
RENEWABLE SOURCES



FRUIT AND
VEGETABLE TRAYS

See pages 272-276 for a detailed explanation of the icons.

BIC® 4 COLOURS®

The world-renowned BIC® 4 Colours® ballpen gives you the convenience of four different ink colours in one ballpoint pen.

FR/
Le stylo à bille de renommée mondiale le BIC® 4 Couleurs® vous offre la commodité de quatre couleurs d'encre différentes dans un seul stylo à bille.

DE/
Der weltbekannte BIC® 4 Colours® Kugelschreiber bietet Ihnen die Verwendung von vier verschiedenen Tintenfarben in einem Stift.

IT/
BIC® 4 Colours® ti offre la comodità di quattro diversi colori di inchiostro in un'unica penna.

ES/
¿A qué esperas para empezar tu colección? El mundialmente reconocido bolígrafo BIC® 4 Colours® te ofrece la comodidad de cuatro colores de tinta diferentes en el mismo bolígrafo.



1101 BIC® 4 Colours® with lanyard



1100 BIC® 4 Colours®



1100 BIC® 4 Colours® Metallic Foil

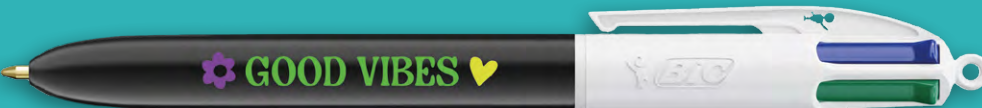

1133 BIC® 4 Colours® ECO
1134 with lanyard



1123 BIC® 4 Colours® Rainbow Decor
1124 with lanyard



1069 BIC® 4 Colours® Bicolor
1076 with lanyard



1074 BIC® 4 Colours® Gradient
1075 with lanyard



1071 BIC® 4 Colours® Pastel
1072 with lanyard

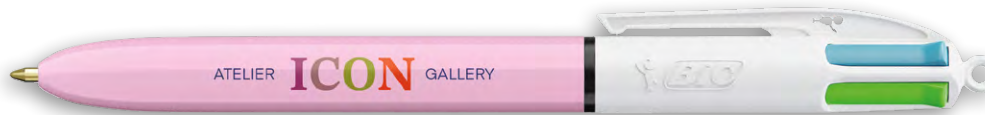

1102 BIC® 4 Colours® Fashion
1108 with lanyard



1097 BIC® 4 Colours® Sun
1098 with lanyard



1109 BIC® 4 Colours® Fine
1111 with lanyard



1114 BIC® 4 Colours® Fluo
1116 with lanyard



1057 BIC® 4 Colours® Glacé
1058 with lanyard



1106 BIC® 4 Colours® Shine
1107 with lanyard



1060 BIC® 4 Colours® Soft
1063 with lanyard



1061 BIC® 4 Colours® Wood Style
1064 with lanyard



1067 BIC® 4 Colours®
Flags Collection
1068 with lanyard



1099 BIC® 4 Colours® 3+1^{HB}

BIC®
GRAPHIC

BIC®
WRITING INSTRUMENTS

OTHER WRITING
INSTRUMENTS

NOTEBOOKS

BIC® / DIEEP® LIGHTERS
AND BIC® CASES

BIC®
PACKAGING

GENERAL
INFORMATION

BIC® 4 COLOURS®

collection 

Always an icon.

Since
1970!



THE SOLUTION
FOR FULL COLOUR
COMMUNICATION!

1100 / 1101

BIC® 4 COLOURS®

1100 Opaque

1101 With lanyard

Ink Colour



01/01

02/02

01/03

01/05

01/02

01/12

01/07

360°
Printing

NEW!

Metallic Foil



Refill
service on
request

1:1 scale

FR /
Toujours une icône.

DE /
Immer ein Kultmodell.

IT /
Sempre un'icona.

ES /
Siempre un icono.

1100 / 1101

BIC® 4 COLOURS®
1100/1101

- A SP:** max. 4 col.
- B DG/MF:** Digital print (area for images)
- C BP:** full-colour
- D SP:** 1 col. (only for white upper parts)

MOQ 250 units (SP, DG)
MOQ 100 units (BP)

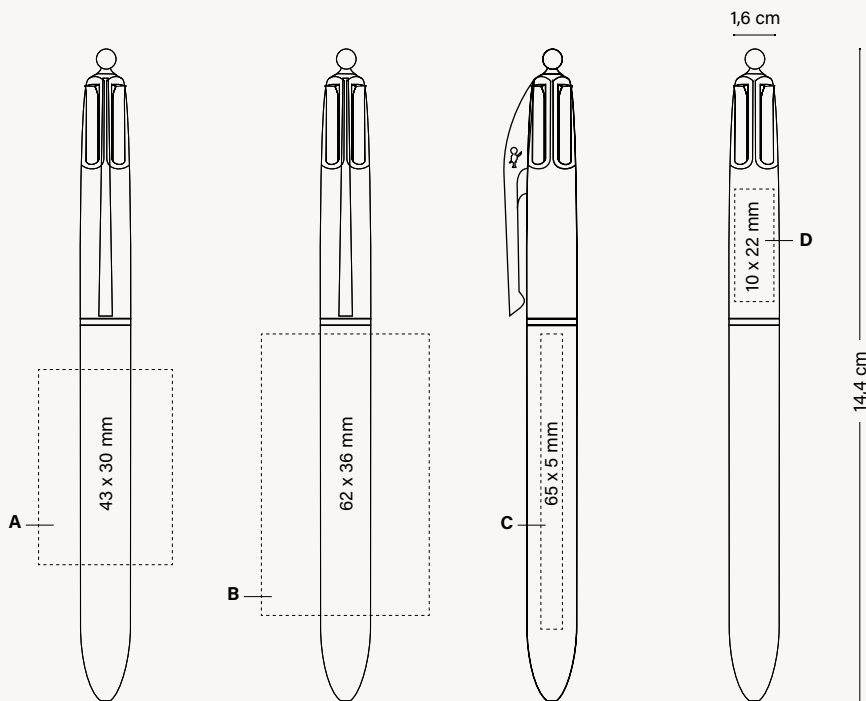

OPTIONAL SPECIAL PACKAGING



+ INFO PAGES 254 TO 265

Can be used as bookmark

(1, 2 & 3 units)

EXTERNAL PACKAGING



PERSONALISED COLOURS



MANUFACTURED AND PRINTED IN BIC FACTORIES



MADE IN FRANCE



REGULATORY COMPLIANCE



ISO certified

WRITING MODES



BALLPEN M Ø 1 MM

PRINTING TECHNIQUES



SP SCREEN PRINTING



DG DIGITAL



BP BRIPEPIX™



MF METALLIC FOIL

SUSTAINABILITY



IMPRIM'VERT®



100% ELECTRICITY COMING FROM RENEWABLE SOURCES



CHECK OUT THE VIDEO

New barrel made from 98% recycled plastic coming from car parts*.

1133 / 1134

BIC® 4 COLOURS® ECO

1133 Opaque

1134 With lanyard

Ink Colour



NEW!



01/1E

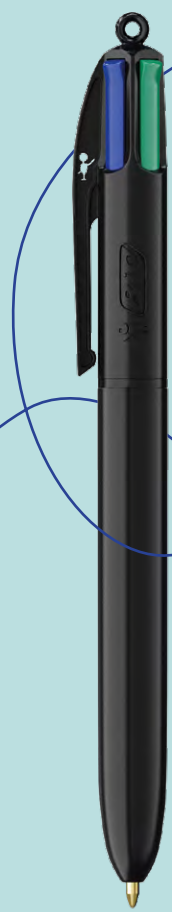

02/3E

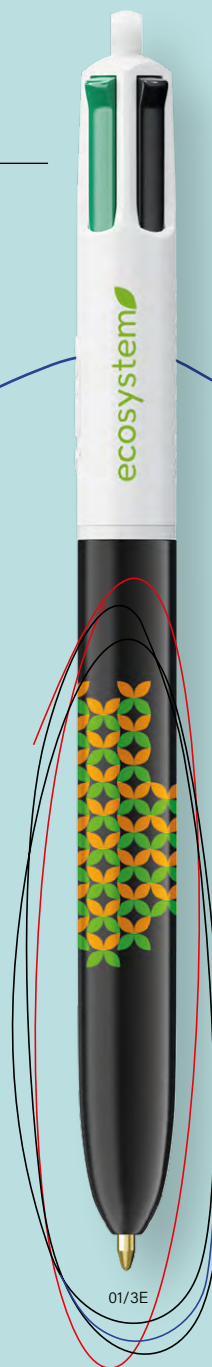

01/3E

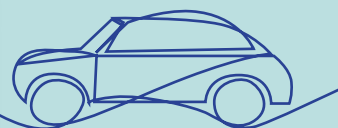

Barrel



Refill service on request

1:1 scale

FR / **Nouveau corps fabriqué à partir de 98 % de plastique recyclé provenant de pièces automobiles*.**

DE / **Neuer Schaft hergestellt aus 98 % recyceltem Kunststoff aus Autoteilen*.**

IT / **Nuovo fusto realizzato con il 98% di plastica riciclata proveniente da parti di automobili*.**

ES / **Nuevo cuerpo fabricado con un 98 % de plástico reciclado procedente de piezas de automóviles*.**

BIC® 4 COLOURS® ECO

1133 / 1134

BIC® 4 COLOURS® ECO
1133/1134

A SP: max. 3 col.
B SP: 1 col. (only for white upper parts)

MOQ 250 units

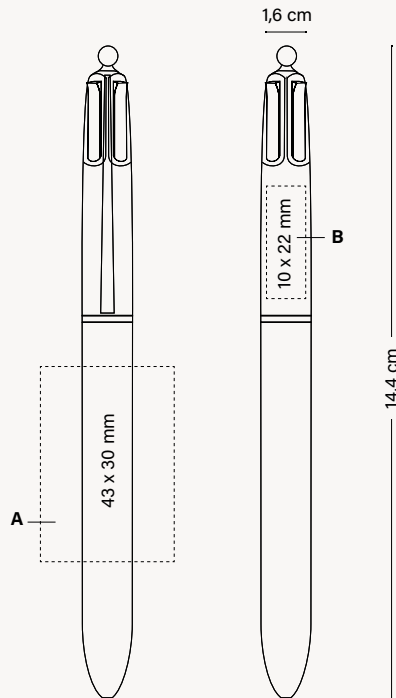

OPTIONAL SPECIAL PACKAGING



+ INFO PAGES 254 TO 265

Can be used as bookmark

(1, 2 & 3 units)

EXTERNAL PACKAGING



250 ± 3.2KG



PERSONALISED COLOURS



MANUFACTURED AND PRINTED IN BIC FACTORIES



FABRIQUÉ EN FRANCE

MADE IN FRANCE



REGULATORY COMPLIANCE



ISO certified

WRITING MODES



BALLPEN M
Ø 1 MM

PRINTING TECHNIQUES



SCREEN PRINTING

SUSTAINABILITY



IMPRIM'VERT®



100% ELECTRICITY COMING FROM RENEWABLE SOURCES

BIC GRAPHIC

BIC® WRITING INSTRUMENTS

OTHER WRITING INSTRUMENTS

NOTEBOOKS

BIC® / DIEEP® LIGHTERS AND BIC® CASES

BIC® PACKAGING

GENERAL INFORMATION

* The percentage is calculated based on total weight of the barrel. Due to the recycled content of the raw materials used to make the product, we cannot guarantee that the colours shown in the catalogue or colours customised to order will always have the same colour and appearance.

Colour Your World!

Your Life, Your Style.

1123 / 1124

BIC® 4 COLOURS® RAINBOW DECOR

1123

1124 With Lanyard

Ink Colour



01/9Y

1:1 scale



Refill
service on
request

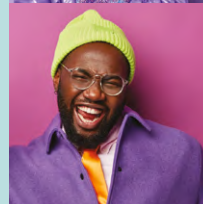
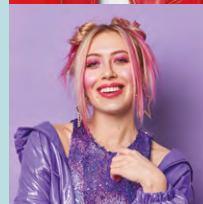
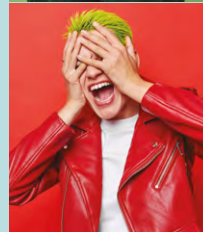
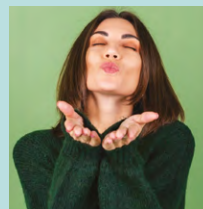

FR /

Colorez votre monde !

Votre vie, votre style.

DE /

Bringe Farbe in deine Welt!

Dein Leben, dein Stil.

IT /

Colora il tuo mondo!

La tua vita, il tuo stile.

ES /

¡Colorea tu mundo!

Tu vida, tu estilo.

BIC® 4 COLOURS® RAINBOW DECOR

1123 / 1124

BIC® 4 COLOURS® RAINBOW DECOR
1123/1124

A SP: max. 2 col.
B SP: max. 1 col.

MOQ 250 units (SP)

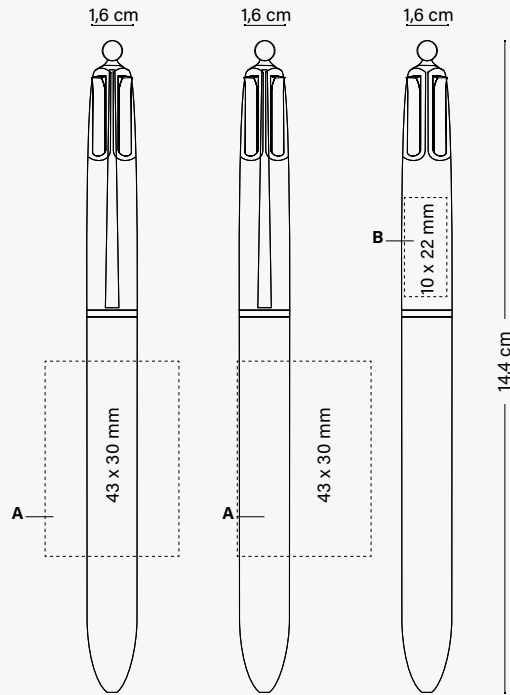

OPTIONAL SPECIAL PACKAGING



+ INFO PAGES 254 TO 265



*Can be used
as bookmark*



(1, 2 & 3 units)

EXTERNAL PACKAGING



250 ± 3,2KG



PERSONALISED
COLOURS



MANUFACTURED
AND PRINTED IN
BIC FACTORIES



FABRIQUÉ
EN FRANCE
MADE IN FRANCE



REGULATORY
COMPLIANCE



ISO
certified

WRITING
MODES



BALLPEN M
Ø 1 MM

PRINTING
TECHNIQUES



SCREEN PRINTING

SUSTAINABILITY



IMPRIM'VERT®



100% ELECTRICITY
COMING FROM
RENEWABLE SOURCES



CHECK OUT THE VIDEO

BIC
GRAPHIC

BIC®
WRITING INSTRUMENTS

OTHER WRITING
INSTRUMENTS

NOTEBOOKS

BIC® / DEEPP® LIGHTERS
AND BIC® CASES

BIC®
PACKAGING

GENERAL
INFORMATION

See pages 272-276 for a detailed explanation of the icons.

Metallic aesthetics with an artistic touch.

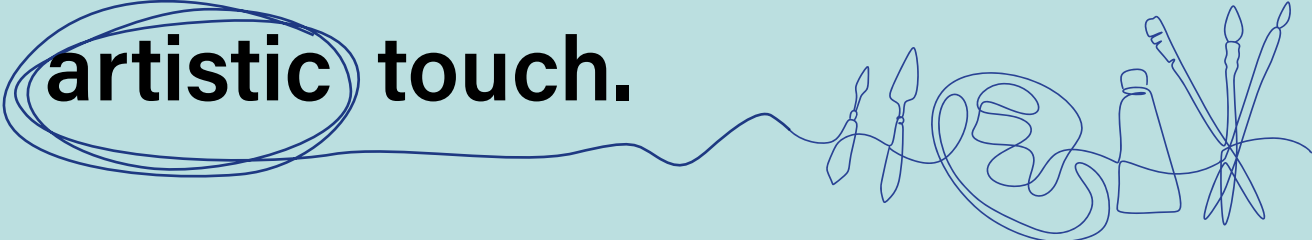

1069 / 1076

BIC® 4 COLOURS® BICOLOR
1069
1076 With Lanyard

Ink Colour



01/04G/47



01/05G/47



01/80/47



01/4R/47



Refill service on request

1:1 scale

FR /
Une esthétique métallique avec une touche artistique.

DE /
Ein Metallic-Look mit künstlerischer Note.

IT /
Look metallico con un tocco artistico.

ES /
Estética metálica con un toque artístico.

BIC® 4 COLOURS® BICOLOR

1069 / 1076

BIC® 4 COLOURS® BICOLOR®
1069/1076

A SP: max. 2 col.
B SP: max. 1 col.

MOQ 250 units

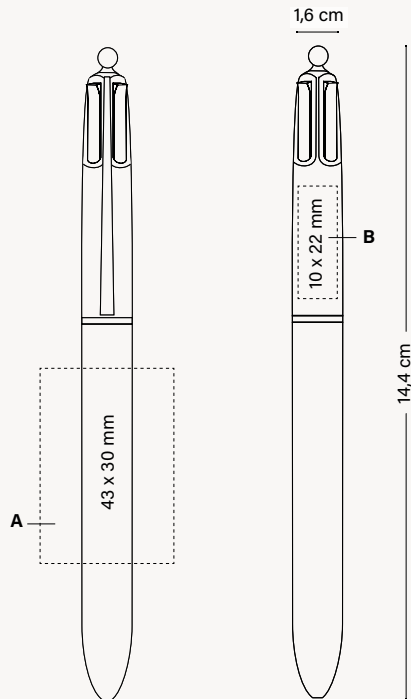

OPTIONAL SPECIAL PACKAGING



ECO SLEEVE

+ INFO PAGES 254 TO 265



PLASTIC POUCH

Can be used as bookmark



WINDOW BOX



BIC® COLLECTION BOX

(1, 2 & 3 units)

EXTERNAL PACKAGING



250 ± 3,2KG



PERSONALISED COLOURS



MANUFACTURED AND PRINTED IN BIC FACTORIES



MADE IN FRANCE



REGULATORY COMPLIANCE



ISO certified

WRITING MODES



BALLPEN M
Ø 1 MM

PRINTING TECHNIQUES



SCREEN PRINTING

SUSTAINABILITY



IMPRIM'VERT®



100% ELECTRICITY COMING FROM RENEWABLE SOURCES



CHECK OUT THE VIDEO

See pages 272-276 for a detailed explanation of the icons.

GENERAL INFORMATION

BIC® PACKAGING

BIC® / DIEEP® LIGHTERS AND BIC® CASES

NOTEBOOKS

OTHER WRITING INSTRUMENTS

BIC® WRITING INSTRUMENTS

BIC GRAPHIC

The most summery vibes.

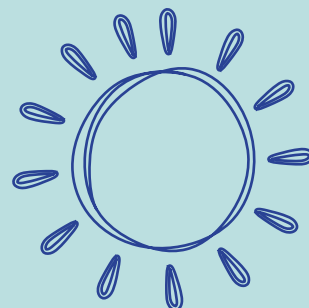

1074 / 1075

BIC® 4 COLOURS® GRADIENT

1074

1075 With Lanyard

Ink Colour



Refill
service on
request

1:1 scale

01/3G/8D/4R

FR /
**Un look
total d'été.**

DE /
**Die beste
Sommer-Stimmung.**

IT /
**Un'esplosione di
colori estivi.**

ES /
**Las vibraciones
más veraniegas.**

BIC® 4 COLOURS® GRADIENT

1074 / 1075

BIC® 4 COLOURS® GRADIENT

1074/1075

A SP: max. 2 col.

B SP: max. 1 col.

MOQ 250 units

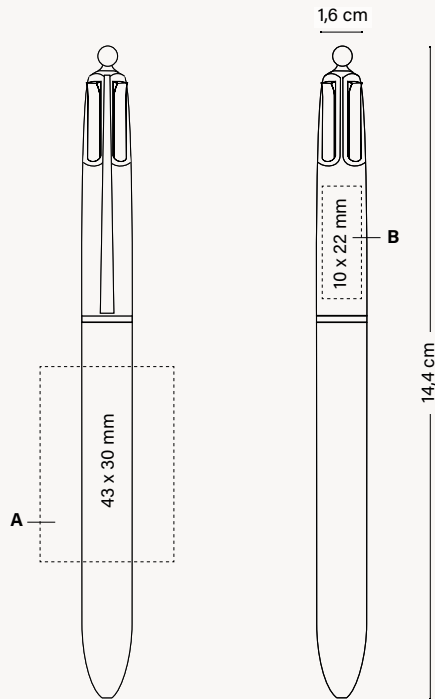

OPTIONAL SPECIAL PACKAGING



ECO SLEEVE

+ INFO PAGES 254 TO 265



PLASTIC POUCH



WINDOW BOX



BIC® COLLECTION BOX

Can be used as bookmark

(1, 2 & 3 units)

EXTERNAL PACKAGING



250 ± 3,2KG



PERSONALISED COLOURS



MANUFACTURED AND PRINTED IN BIC FACTORIES



MADE IN FRANCE



REGULATORY COMPLIANCE



ISO certified

WRITING MODES



BALLPEN M
Ø 1 MM

PRINTING TECHNIQUES



SCREEN PRINTING

SUSTAINABILITY



IMPRIM'VERT®



100% ELECTRICITY COMING FROM RENEWABLE SOURCES



CHECK OUT THE VIDEO

See pages 272-276 for a detailed explanation of the icons.

Vintage colours, dreamy imagery.

1071 / 1072

BIC® 4 COLOURS® PASTEL

1071 Opaque

1072 With Lanyard

Ink Colour



Refill
service on
request

1:1 scale

FR /
**Des couleurs
vintages,
tout un rêve.**

DE /
**Vintage-Farben,
eine verträumte
Bildsprache.**

IT /
**Colori vintage,
immagini da
sogno.**

ES /
**Colores
vintage
de ensueño.**

BIC® 4 COLOURS® PASTEL

1071 / 1072

BIC® 4 COLOURS® PASTEL

1071/1072

A SP: max. 4 col.
B DG: Digital print

MOQ 250 units

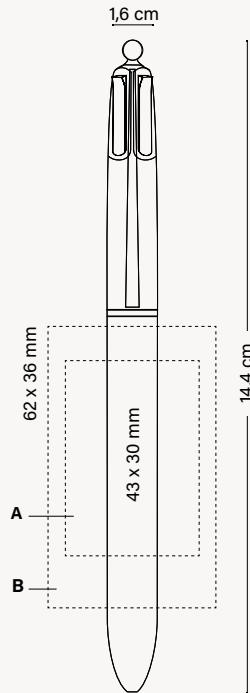

OPTIONAL SPECIAL PACKAGING



ECO SLEEVE

+ INFO PAGES 254 TO 265



PLASTIC POUCH

Can be used as bookmark



WINDOW BOX



BIC® COLLECTION BOX

(1, 2 & 3 units)



250 ± 3,2KG

EXTERNAL PACKAGING



PERSONALISED COLOURS



MANUFACTURED AND PRINTED IN BIC FACTORIES



MADE IN FRANCE



REGULATORY COMPLIANCE



ISO certified

WRITING MODES



BALLPEN M Ø 1 MM

PRINTING TECHNIQUES



SCREEN PRINTING



DIGITAL

SUSTAINABILITY



IMPRIM'VERT®



100% ELECTRICITY COMING FROM RENEWABLE SOURCES



CHECK OUT THE VIDEO

See pages 272-276 for a detailed explanation of the icons.

BIC GRAPHIC

BIC® WRITING INSTRUMENTS

OTHER WRITING INSTRUMENTS

NOTEBOOKS

BIC® / DIEEP® LIGHTERS AND BIC® CASES

BIC® PACKAGING

GENERAL INFORMATION

britePix
DIGITAL THE SOLUTION
FOR FULL COLOUR
COMMUNICATION!

1102 / 1108

BIC® 4 COLOURS® FASHION

1102 Opaque
1108 With Lanyard

Ink Colour
●●●●



01/01



01/84

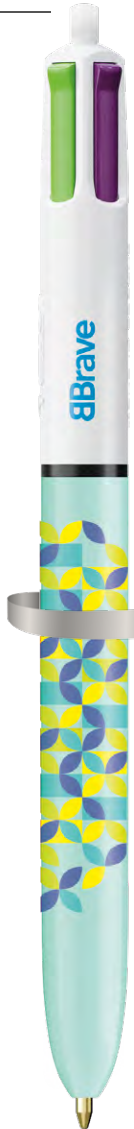

Fashion inks!

360°
Printing



Refill
service on
request

1:1 scale

BIC® 4 COLOURS® FASHION

1102 / 1108

BIC® 4 COLOURS® FASHION
1102/1108

- A SP:** max. 4 col.
- B DG:** Digital print (area for images)
- C BP:** full-colour
- D SP:** max. 1 col.

MOQ 250 units (SP, DG)
MOQ 100 units (BP)

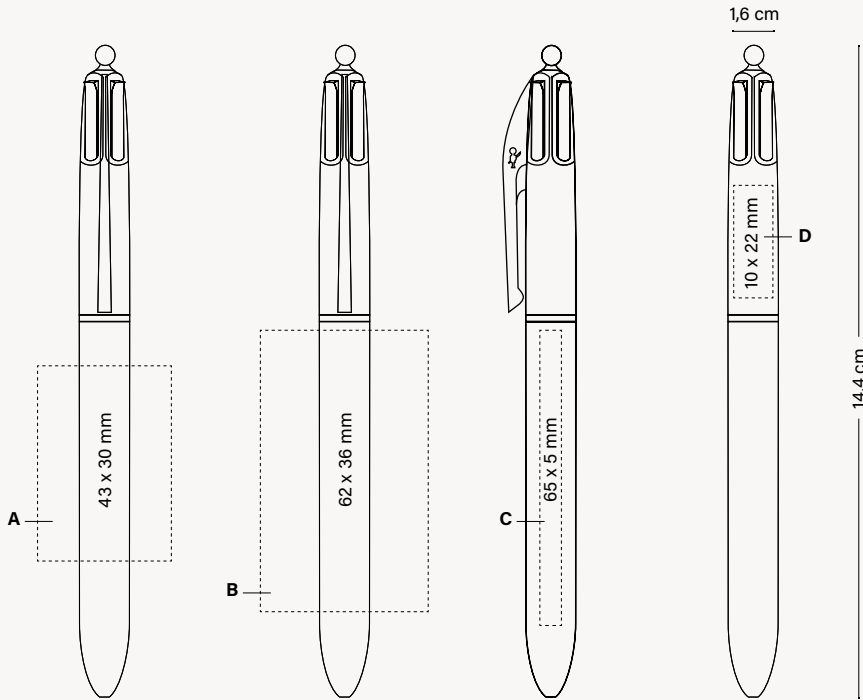

OPTIONAL SPECIAL PACKAGING



ECO SLEEVE

+ INFO PAGES 254 TO 265



PLASTIC POUCH

Can be used as bookmark



WINDOW BOX



BIC® COLLECTION BOX

(1, 2 & 3 units)

EXTERNAL PACKAGING



250 ± 3,2KG



PERSONALISED COLOURS



MANUFACTURED AND PRINTED IN BIC FACTORIES



FABRIQUÉ EN FRANCE

MADE IN FRANCE



REGULATORY COMPLIANCE



ISO certified

WRITING MODES



BALLPEN M
Ø 1 MM

PRINTING TECHNIQUES



SCREEN PRINTING



BP
BRITEPIX™
BRITEPIX™ TEXTURE
BRITEPIX™ PERSONALISATION

SUSTAINABILITY



IMPRIM'VERT®



100% ELECTRICITY COMING FROM RENEWABLE SOURCES

BIC GRAPHIC

BIC® WRITING INSTRUMENTS

OTHER WRITING INSTRUMENTS

NOTEBOOKS

BIC® / DIEEP® LIGHTERS AND BIC® CASES

BIC® PACKAGING

GENERAL INFORMATION

See pages 272-276 for a detailed explanation of the icons.

britePix
DIGITAL THE SOLUTION
FOR FULL COLOUR
COMMUNICATION!

1097 / 1098

BIC® 4 COLOURS® SUN

1097 Opaque
1098 With Lanyard

Ink Colour



*Flashy colours:
orange & yellow*

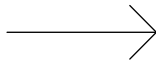

01/12

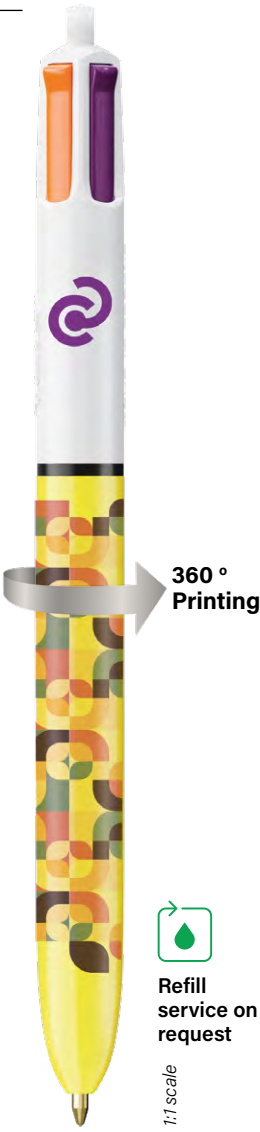

01/12

1097 / 1098

BIC® 4 COLOURS® SUN

1097/1098

A SP: max. 4 col.

B DG: Digital print (area for images)

C BP: full-colour

D SP: max. 1 col.

MOQ 250 units (SP, DG)

MOQ 100 units (BP)

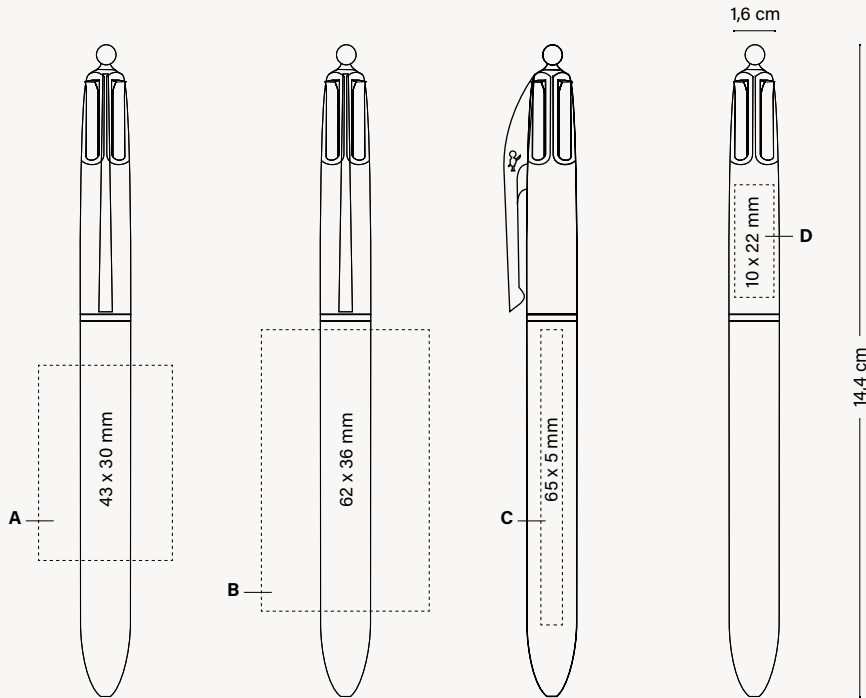

OPTIONAL SPECIAL PACKAGING



+ INFO PAGES 254 TO 265

Can be used as bookmark

EXTERNAL PACKAGING

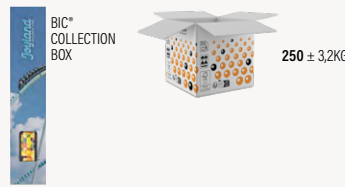

(1, 2 & 3 units)



PERSONALISED COLOURS



MANUFACTURED AND PRINTED IN BIC FACTORIES



FABRIQUE EN FRANCE

MADE IN FRANCE



REGULATORY COMPLIANCE



ISO certified

WRITING MODES



BALLPEN M
Ø 1 MM

PRINTING TECHNIQUES



SCREEN PRINTING



DIGITAL



BRITEPIX™
BRITEPIX™ TEXTURE
BRITEPIX™ PERSONALISATION

SUSTAINABILITY



IMPRIM'VERT®



100% ELECTRICITY COMING FROM RENEWABLE SOURCES



THE SOLUTION FOR FULL COLOUR COMMUNICATION!

1109 / 1111

BIC® 4 COLOURS® FINE

1109 Opaque
1111 With Lanyard

Ink Colour
●●●●



01/10



360° Printing



Refill service on request

1:1 scale

01/10

0.8 mm tip!

BIC® 4 COLOURS® FINE

1109 / 1111

BIC® 4 COLOURS® FINE

1109/1111

- A SP:** max. 4 col.
- B DG:** Digital print
- C BP:** full-colour
- D SP:** max. 1 col.

MOQ 250 units (SP, DG)
MOQ 100 units (BP)

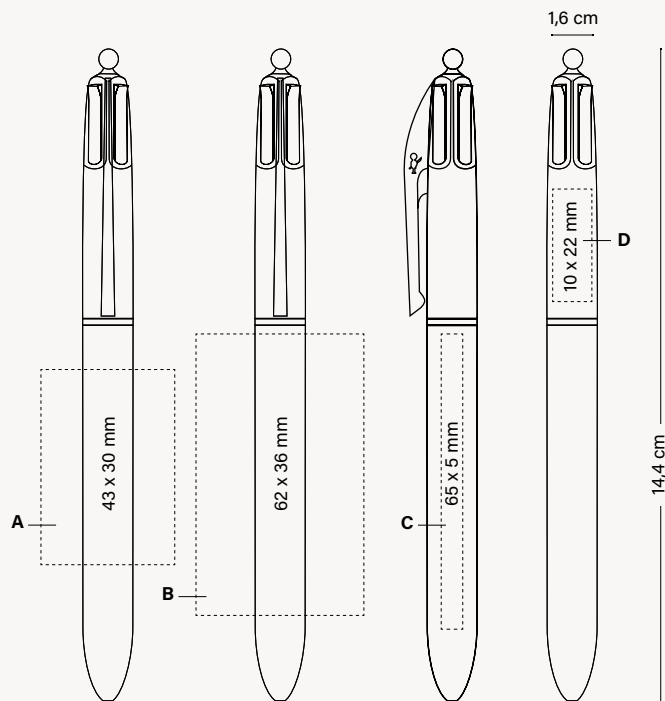

OPTIONAL SPECIAL PACKAGING



ECO SLEEVE

+ INFO PAGES 254 TO 265



PLASTIC POUCH



WINDOW BOX



BIC® COLLECTION BOX

Can be used as bookmark

(1, 2 & 3 units)

EXTERNAL PACKAGING



250 ± 3,2KG



PERSONALISED COLOURS



MANUFACTURED AND PRINTED IN BIC FACTORIES



MADE IN FRANCE



REGULATORY COMPLIANCE



ISO certified

WRITING MODES



BALLPEN M
Ø 0,8 MM

PRINTING TECHNIQUES



SCREEN PRINTING



DIGITAL



BRITEPIX™
BRITEPIX™ TEXTURE
BRITEPIX™ PERSONALISATION

SUSTAINABILITY



IMPRIM'VERT®



100% ELECTRICITY COMING FROM RENEWABLE SOURCES

BIC GRAPHIC

BIC® WRITING INSTRUMENTS

OTHER WRITING INSTRUMENTS

NOTEBOOKS

BIC® / DIEEP® LIGHTERS AND BIC® CASES

BIC® PACKAGING

GENERAL INFORMATION

See pages 272-276 for a detailed explanation of the icons.

1114 / 1116

BIC® 4 COLOURS® FLUO
1114 Opaque
1116 With Lanyard

Ink Colour
●●●●

4 inks, one of them fluo!



01/4D



01/4D

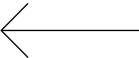

Refill service on request

1:1 scale

BIC® 4 COLOURS® FLUO

1114 / 1116

BIC® 4 COLOURS® FLUO

1114/1116

A SP: max. 4 col.
B BP: full-colour
C SP: max. 1 col.

MOQ 250 units (SP)
 MOQ 100 units (BP)

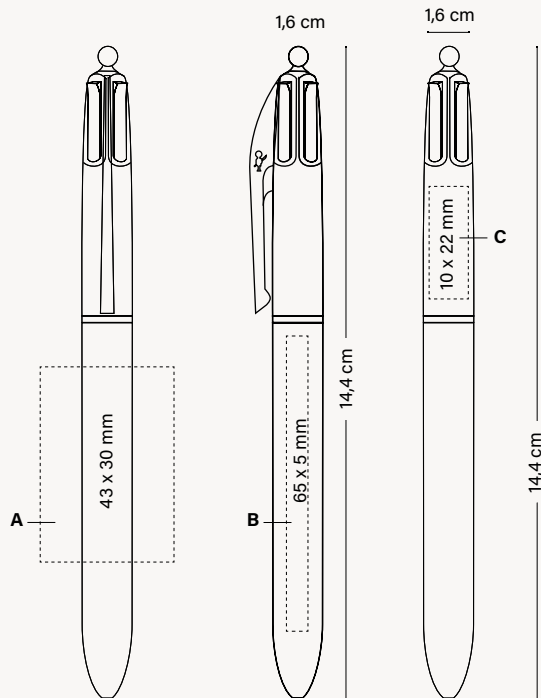

OPTIONAL SPECIAL PACKAGING



ECO SLEEVE



PLASTIC POUCH



WINDOW BOX



BIC® COLLECTION BOX

+ INFO PAGES 254 TO 265

Can be used as bookmark

(1, 2 & 3 units)

EXTERNAL PACKAGING



250 ± 3,2KG



PERSONALISED COLOURS



MANUFACTURED AND PRINTED IN BIC FACTORIES



FABRIQUÉ EN FRANCE
MADE IN FRANCE



REGULATORY COMPLIANCE



ISO certified

WRITING MODES



BALLPEN M 0.1 MM

PRINTING TECHNIQUES



SP SCREEN PRINTING



BP BRITEPIX™ TEXTURE BRITEPIX™ PERSONALISATION

SUSTAINABILITY



IMPRIM'VERT®



100% ELECTRICITY COMING FROM RENEWABLE SOURCES

BIC GRAPHIC

BIC® WRITING INSTRUMENTS

OTHER WRITING INSTRUMENTS

NOTEBOOKS

BIC® / DIIPEE® LIGHTERS AND BIC® CASES

BIC® PACKAGING

GENERAL INFORMATION

See pages 272-276 for a detailed explanation of the icons.

Our classic pen dressed up.

1057 / 1058

BIC® 4 COLOURS® GLACÉ

1057

1058 With Lanyard

Ink Colour

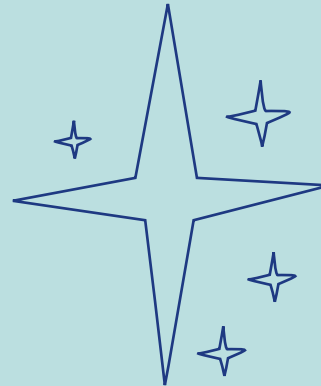

01/76



01/47G



01/03G



01/05G



01/04G



02/47G



02/76



01/14G



Refill service on request

1:1 scale

FR /

Notre stylo classique dans sa plus belle tenue.

DE /

Unser klassischer Kugelschreiber kleidet sich festlich.

IT /

La nostra penna iconica in abito elegante.

ES /

Nuestro bolígrafo clásico se viste de gala.

BIC® 4 COLOURS® GLACÉ

1057 / 1058

BIC® 4 COLOURS® GLACÉ
1057/1058

A SP: max. 2 col.
B SP: max. 1 col. (only for white upper parts)

MOQ 250 units

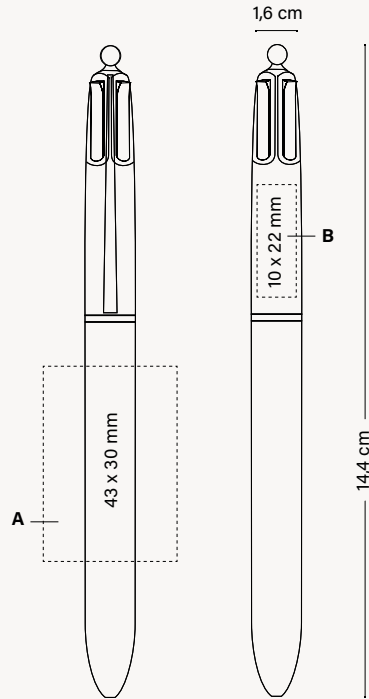

PERSONALISED COLOURS



MANUFACTURED AND PRINTED IN BIC FACTORIES



FABRIQUÉ EN FRANCE
MADE IN FRANCE



REGULATORY COMPLIANCE



ISO certified

WRITING MODES



BALLPEN M
Ø 1 MM

PRINTING TECHNIQUES



SP
SCREEN PRINTING

SUSTAINABILITY



IMPRIM'VERT®



100% ELECTRICITY COMING FROM RENEWABLE SOURCES

OPTIONAL SPECIAL PACKAGING

EXTERNAL PACKAGING



ECO SLEEVE



PLASTIC POUCH



WINDOW BOX



BIC® COLLECTION BOX



250 ± 3,2KG

+ INFO PAGES 254 TO 265

Can be used as bookmark

(1, 2 & 3 units)

BIC GRAPHIC

BIC® WRITING INSTRUMENTS

OTHER WRITING INSTRUMENTS

NOTEBOOKS

BIC® / DIBEE® LIGHTERS AND BIC® CASES

BIC® PACKAGING

GENERAL INFORMATION

See pages 272-276 for a detailed explanation of the icons.

1106 / 1107

BIC® 4 COLOURS® SHINE

1106
1107 With Lanyard

Ink Colour
● ● ● ●



01/75



01/26



01/7G



01/34



01/97

Super shiny barrels!



Refill service on request

1:1 scale

BIC® 4 COLOURS® SHINE

1106 / 1107

BIC® 4 COLOURS® SHINE
1106/1107

A SP: max. 2 col.
B LE
C LE
D LE: 360°
E SP: max. 1 col.

MOQ 250 units

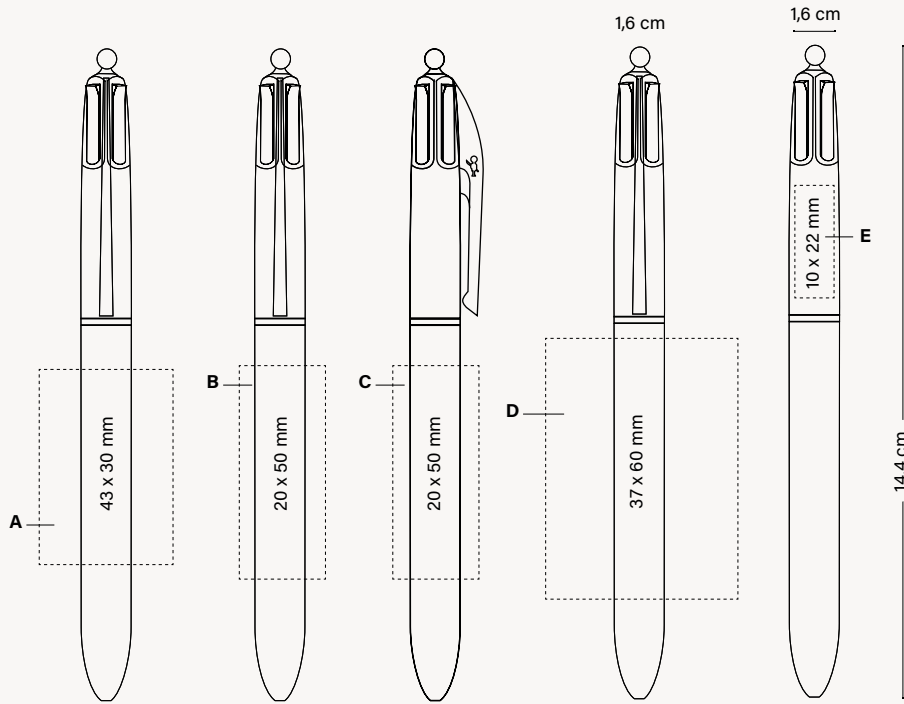

OPTIONAL SPECIAL PACKAGING



ECO SLEEVE

+ INFO PAGES 254 TO 265



PLASTIC POUCH



WINDOW BOX



BIC® COLLECTION BOX

Can be used as bookmark

(1, 2 & 3 units)

EXTERNAL PACKAGING



250 ± 3,2KG



PERSONALISED COLOURS



MANUFACTURED AND PRINTED IN BIC FACTORIES



FABRIQUÉ EN FRANCE

MADE IN FRANCE



REGULATORY COMPLIANCE



ISO certified

WRITING MODES



BALLPEN M Ø 1 MM

PRINTING TECHNIQUES



SCREEN PRINTING



LASER

SUSTAINABILITY



IMPRIM'VERT®



100% ELECTRICITY COMING FROM RENEWABLE SOURCES

BIC GRAPHIC

BIC® WRITING INSTRUMENTS

OTHER WRITING INSTRUMENTS

NOTEBOOKS

BIC® / DIIPEE® LIGHTERS AND BIC® CASES

BIC® PACKAGING

GENERAL INFORMATION

See pages 272-276 for a detailed explanation of the icons.



A soft touch you won't want to put down!

Feel it !

1060 / 1063

BIC® 4 COLOURS® SOFT

1060 Opaque

1063 With Lanyard

Ink Colour



01/03F



01/02F



02/02F



01/07F



Feel the softness in your hands



Refill service on request

1:1 scale

FR /

Un toucher doux que vous ne lâcherez plus !

DE /

Eine samtige Oberfläche, die Sie nicht mehr aus der Hand legen möchten.

IT /

Una superficie morbida che non vorrai mai smettere di toccare!

ES /

¡Un tacto suave que no querrás dejar de tocar!

BIC® 4 COLOURS® SOFT

1060 / 1063

BIC® 4 COLOURS® SOFT

1060/1063

A SP: max. 1 col.

B SP: max. 1 col. (only for white upper parts)

MOQ 250 units

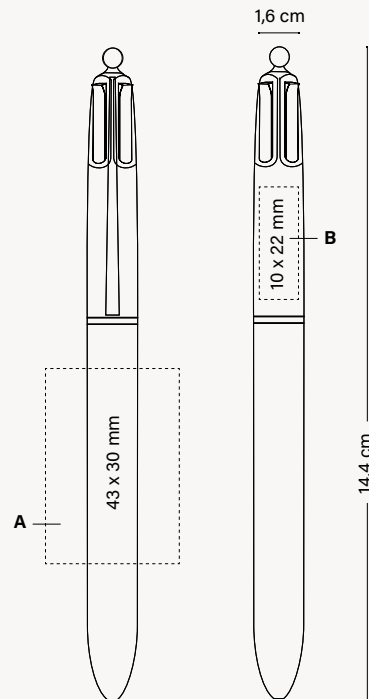

OPTIONAL SPECIAL PACKAGING



+ INFO PAGES 254 TO 265



Can be used as bookmark



WINDOW BOX



BIC® COLLECTION BOX

(1, 2 & 3 units)

EXTERNAL PACKAGING



250 ± 3,2KG



PERSONALISED COLOURS



MANUFACTURED AND PRINTED IN BIC FACTORIES



MADE IN FRANCE



REGULATORY COMPLIANCE



ISO certified

WRITING MODES



BALLPEN M Ø 1 MM

PRINTING TECHNIQUES



SCREEN PRINTING

SUSTAINABILITY



IMPRIM'VERT®



100% ELECTRICITY COMING FROM RENEWABLE SOURCES

BIC® GRAPHIC

BIC® WRITING INSTRUMENTS

OTHER WRITING INSTRUMENTS

NOTEBOOKS

BIC® / DIIPEE® LIGHTERS AND BIC® CASES

BIC® PACKAGING

GENERAL INFORMATION

See pages 272-276 for a detailed explanation of the icons.



Be impressed with the spectacular wood finish!

1061 / 1064

BIC® 4 COLOURS® WOOD STYLE

1061 Opaque

1064 With Lanyard

Ink Colour



Wood Vibes

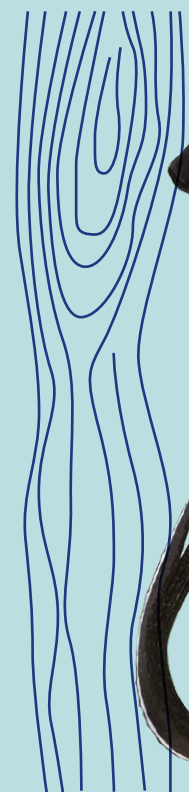

01/6AW



01/05W



02/6AW



01/02W



Bring warmth to your brand



Refill service on request

1:1 scale

FR /
Laissez-vous impressionner par cette finition spectaculaire !

DE /
Lassen Sie sich von der spektakulären Holzoptik beeindrucken!

IT /
Lasciatevi impressionare dalla spettacolare finitura in legno!

ES /
¡Déjate impresionar por el espectacular acabado efecto madera!

BIC® 4 COLOURS® WOOD STYLE

1061 / 1064

BIC® 4 COLOURS® WOOD STYLE

1061/1064

A SP: max. 2 col.

B SP: max. 1 col. (only for white upper parts)

MOQ 250 units

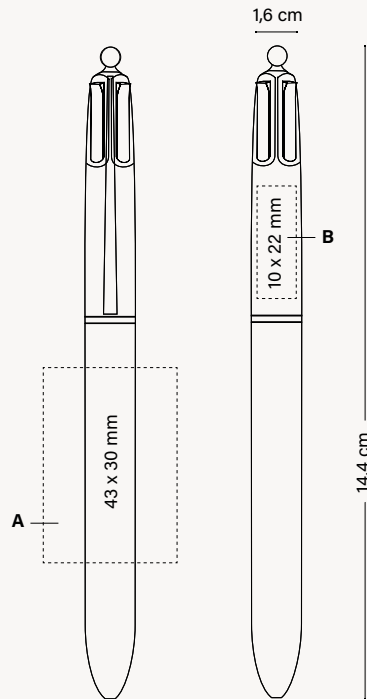

OPTIONAL SPECIAL PACKAGING



+ INFO PAGES 254 TO 265



Can be used as bookmark



(1, 2 & 3 units)

EXTERNAL PACKAGING



250 ± 3,2KG



PERSONALISED COLOURS



MANUFACTURED AND PRINTED IN BIC FACTORIES



MADE IN FRANCE



REGULATORY COMPLIANCE



ISO certified

WRITING MODES



BALLPEN M 0.1 MM

PRINTING TECHNIQUES



SCREEN PRINTING

SUSTAINABILITY



IMPRIM'VERT®



100% ELECTRICITY COMING FROM RENEWABLE SOURCES

BIC GRAPHIC

BIC WRITING INSTRUMENTS

OTHER WRITING INSTRUMENTS

NOTEBOOKS

BIC / DIIEEP® LIGHTERS AND BIC® CASES

BIC® PACKAGING

GENERAL INFORMATION

See pages 272-276 for a detailed explanation of the icons.

Celebrate heritage.

1067 / 1068

BIC® 4 COLOURS® FLAGS COLLECTION

1067

1068 With Lanyard

Ink Colour



01/03/47/05



01/02/03/12



02/02/03/12



01/03/47/04



01/03/12/03



Refill service on request

1:1 scale

FR /
Célébrer le patrimoine !

DE /
Feiern Sie Ihre Geschichte!

IT /
Celebra la tradizione!

ES /
¡Celebra el legado!

BIC® 4 COLOURS® FLAGS COLLECTION

1067 / 1068

BIC® 4 COLOURS® FLAGS COLLECTION

1067/1068

A SP: max. 2 col.

B SP: max. 1 col. (only for white upper parts)

MOQ 250 units

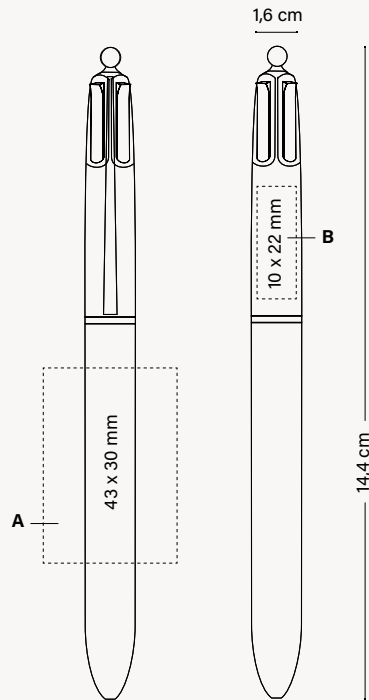

OPTIONAL SPECIAL PACKAGING



+ INFO PAGES 254 TO 265

Can be used as bookmark

(1, 2 & 3 units)

EXTERNAL PACKAGING



250 ± 3,2KG



PERSONALISED COLOURS



MANUFACTURED AND PRINTED IN BIC FACTORIES



FABRIQU  EN FRANCE

MADE IN FRANCE



REGULATORY COMPLIANCE



ISO certified

WRITING MODES



BALLPEN M
Ø 1 MM

PRINTING TECHNIQUES



SCREEN PRINTING

SUSTAINABILITY



IMPRIM'VERT®



100% ELECTRICITY COMING FROM RENEWABLE SOURCES



CHECK OUT THE VIDEO

See pages 272-276 for a detailed explanation of the icons.

1099

BIC® 4 COLOURS® 3+1^{HB}
1099 Opaque

Ink Colour
● ● ● ●



Refill
service on
request



01/06

01/06

1:1 scale

BIC® 4 COLOURS® 3+1^{HB}

1099

BIC® 4 COLOURS® 3+1^{HB}

1099 Opaque

A/B LE

MOQ 250 units

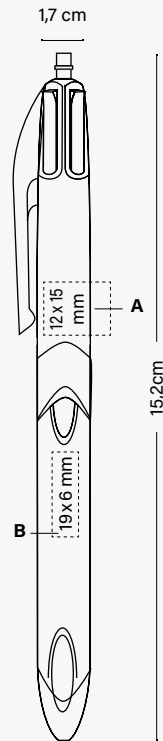

OPTIONAL SPECIAL PACKAGING



PLASTIC
POUCH

+ INFO PAGES 254 TO 265

*Can be used
as bookmark*



BIC®
COLLECTION
BOX

(1, 2 & 3 units)

EXTERNAL PACKAGING



250 ± 3,5 KG



PERSONALISED
COLOURS



MANUFACTURED
AND PRINTED IN
BIC FACTORIES



REGULATORY
COMPLIANCE



WRITING
MODES



BALLPEN M
Ø 1 MM



MECHANICAL PENCIL
MP Ø 0,7MM

PRINTING
TECHNIQUES



LASER

SUSTAINABILITY



IMPRIM'VERT®



100% ELECTRICITY
COMING FROM
RENEWABLE SOURCES



CHECK OUT THE VIDEO

BIC
GRAPHIC

BIC®
WRITING INSTRUMENTS

OTHER WRITING
INSTRUMENTS

NOTEBOOKS

BIC® / DIIPEE® LIGHTERS
AND BIC® CASES

BIC®
PACKAGING

GENERAL
INFORMATION

See pages 272-276 for a detailed explanation of the icons.

Metal accents and modern design, available in classic colors and a variety of finishes.

1290

BIC® METAL PRO
1290 Soft

Colour ink



01F



02F



04F



Maximum writing comfort



German ink for writing up to 8 km.

1:1 scale

FR /
Des accents métalliques et un design moderne, disponible en couleurs classiques et une variété de finitions.

DE /
Metallakzente und modernes Design, erhältlich in klassischen Farben und einer Vielzahl von Ausführungen.

IT /
Particolari metallici, design moderno, disponibile in colori classici e una varietà di finiture.

ES /
Detalles metálicos y diseño moderno, disponible en colores clásicos y una variedad de acabados.

Modern elegance

1290

BIC® METAL PRO
1290 Polished

Colour ink



01E



02E



11 scale
04E



WRITING MODES

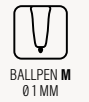

PRINTING TECHNIQUES



SUSTAINABILITY



See pages 272-276 for a detailed explanation of the icons.

1290

BIC® METAL PRO
1290 Matt

Colour ink
● ●



01D



02D



04D

1:1 scale

BIC® METAL PRO

1290

BIC® METAL PRO

1290

A SP: max. 2 col.
(Not available in soft finish)
B LE/SP: max. 1 col.
C LE 360°

MOQ 50 units

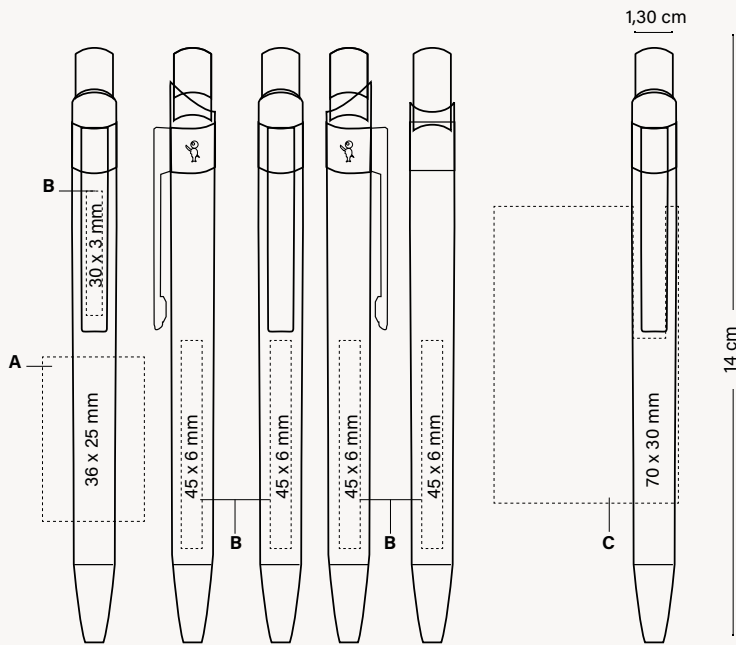

OPTIONAL SPECIAL PACKAGING



+ INFO PAGES 254 TO 265

*Can be used
as bookmark*

EXTERNAL PACKAGING



150 ± 2,5KG



WRITING
MODES



PRINTING
TECHNIQUES



SUSTAINABILITY



BIC
GRAPHIC

BIC®
WRITING INSTRUMENTS

OTHER WRITING
INSTRUMENTS

NOTEBOOKS

BIC® / D'JEEP® LIGHTERS
AND BIC® CASES

BIC®
PACKAGING

GENERAL
INFORMATION

See pages 272-276 for a detailed explanation of the icons.

BIC® ROLLERS AND GELS

Enjoy a smooth writing experience. Glide across the paper easily without smudging thanks to the quick-drying ink, ideal for both left and right-handed people.

FR/

Profitez d'une expérience d'écriture douce, fluide et de longue durée.

Parfait pour les droitiers comme pour les gauchers, il glisse facilement sur le papier et ne fait pas de tâches grâce à son encre à séchage rapide.

DE/

Genießen Sie das sanfte Schreiberlebnis.

Gleitet leicht über das Papier und dank der schnell trocknenden Tinte, ohne zu verschmieren. Ideal für Links- und Rechtshänder.

IT/

Goditi un'esperienza di scrittura morbidissima.

Scorri facilmente sulla carta senza macchiare grazie all' inchiostro ad asciugatura immediata, ideale per mancini.

ES/

Disfruta de una experiencia de escritura suave, fluida y de larga duración.

Se desliza fácilmente a través del papel y sin manchas gracias a la tinta de secado rápido, ideal tanto para las personas zurdas como diestras.

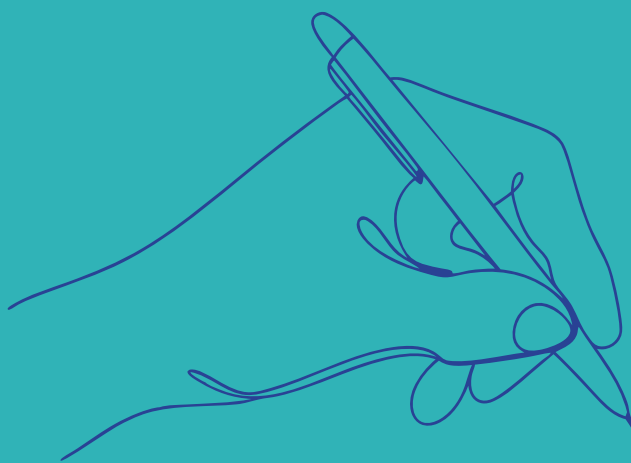



1187
BIC® Grip Roller



1196
BIC® Intensity® Gel Clic
Opaque



1196
BIC® Intensity® Gel Clic
Clear

Smooth
performance

BIC® GRIP ROLLER

1187



High quality medium point liquid ink roller pen for smooth and fluid writing

BIC® GRIP ROLLER

1187

Colour ink



01/35

12/35

10/35

59/35

24/35

07/35

06/35

27/35

02/35

14/35

Also available in blue ink

Also available in blue ink

Also available in blue ink

1:1 scale

BIC® GRIP ROLLER

1187

BIC® GRIP ROLLER

1187

A/B SP: max. 3 col.

MOQ 250 units

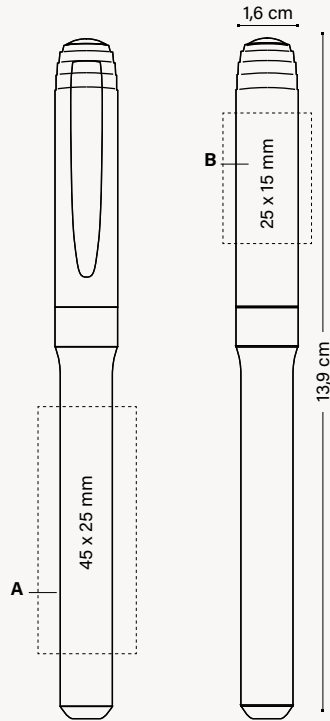

WRITING MODES



PRINTING TECHNIQUES



SUSTAINABILITY



OPTIONAL SPECIAL PACKAGING



+ INFO PAGES 254 TO 265



Can be used as bookmark



Can be used as bookmark



(1, 2 & 3 units)

EXTERNAL PACKAGING



BIC GRAPHIC

BIC® WRITING INSTRUMENTS

OTHER WRITING INSTRUMENTS

NOTEBOOKS

BIC® / DIEEP® LIGHTERS AND BIC® CASES

BIC® PACKAGING

GENERAL INFORMATION

See pages 272-276 for a detailed explanation of the icons.

1196  *Iconic BIC® Boy is embossed*

**BIC® INTENSITY®
GEL CLIC**

1196 Opaque

Colour ink



01

02

1:1 scale

1196

**BIC® INTENSITY®
GEL CLIC**

1196 Clear

Colour ink



92

88

86

1:1 scale

BIC® INTENSITY® GEL CLIC

1196

BIC® INTENSITY® GEL CLIC

1196

A SP: max. 2 col.

B SP: max. 4 col.

MOQ 250 units

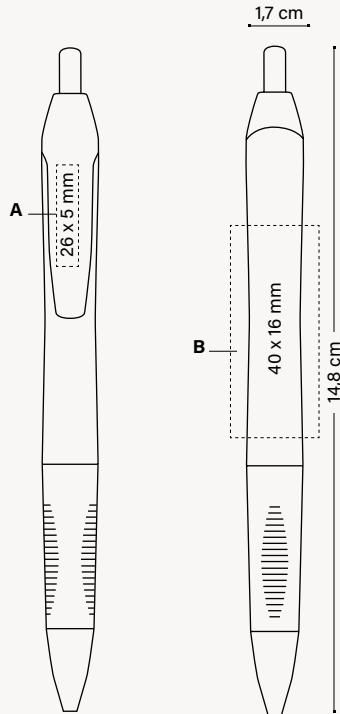

OPTIONAL SPECIAL PACKAGING



+ INFO PAGES 254 TO 265

*Can be used
as bookmark*

EXTERNAL PACKAGING



250 ± 3,7KG



MANUFACTURED
AND PRINTED IN
BIC FACTORIES



REGULATORY
COMPLIANCE



ISO
certified

WRITING
MODES



GEL G
Ø 0,7 MM

PRINTING
TECHNIQUES



SCREEN PRINTING

SUSTAINABILITY



IMPRIM'VERT®

BIC
GRAPHIC

BIC®
WRITING INSTRUMENTS

OTHER WRITING
INSTRUMENTS

NOTEBOOKS

BIC® / DIEEP® LIGHTERS
AND BIC® CASES

BIC®
PACKAGING

GENERAL
INFORMATION

See pages 272-276 for a detailed explanation of the icons.

BIC® HIGHLIGHTERS AND MARKERS

BIC® Markers offer you products specifically designed to write in a highly visible way and mark on surfaces or material that other writing instruments cannot mark on. Make your ideas visible and express yourself whatever the surface with BIC® Markers.

FR/

Les surligneurs et les marqueurs BIC® ont été conçus pour écrire d'une manière visible sur une large gamme de surfaces. Exprimez-vous avec clarté sur n'importe quelle surface.

DE/

BIC®-Textmarker sind Produkte, die speziell konzipiert wurden, um besonders sichtbar zu schreiben und auf Oberflächen oder Materialien zu markieren, wo herkömmliche Schreibgeräte an ihre Grenzen stoßen.

IT/

BIC® ti offre prodotti appositamente progettati per scrivere in modo ben visibile su superfici e materiali su cui altri strumenti di scrittura non possono scrivere. Rendi visibili le tue idee ed esprimiti su qualsiasi superficie con pennarelli BIC®.

ES/

Los subrayadores y marcadores BIC® están diseñados para escribir visiblemente en un amplio rango de superficies. Exprésate con claridad sin importar la superficie.

Mark it



1192
BIC® Brite Liner® Grip
Opaque



1132
BIC® Highlighter Flat



1651
BIC® Velleda® White
Board Marker Fine



1213
BIC® Velleda® White
Board Marker Grip



1214
BIC® Mark-it
Permanent Marker



1214
BIC® Mark-it
Permanent Marker

Underline it



1192

BIC® BRITE LINER® GRIP
1192



Bright colours to highlight
or underline your ideas.

TWO WIDTHS:
Fine 1.6 mm and
Large 3.3 mm.



Textured rubberised grip for
more precision and control

Water-based ink.



12



Colour ink

10



Colour ink

24



Colour ink

59



Colour ink

14



Colour ink

1:1 scale

BIC® BRITE LINER® GRIP

1192

BIC® BRITE LINER® GRIP

1192

A/B SP: max. 3 col.

MOQ 250 units

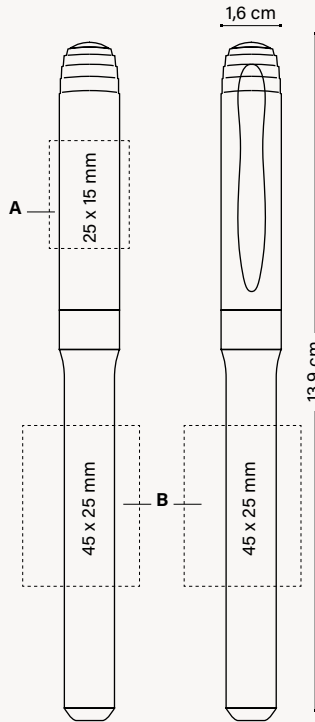

OPTIONAL SPECIAL PACKAGING



+ INFO PAGES 254 TO 265

Can be used
as bookmark



(1, 2 & 3 units)

EXTERNAL PACKAGING



250 ± 2,8KG



MANUFACTURED
AND PRINTED IN
BIC FACTORIES



FABRIQUÉ
EN FRANCE

MADE IN FRANCE



REGULATORY
COMPLIANCE



ISO
certified



WILL NOT DRY OUT IN 24H

WRITING
MODES



HIGHLIGHTER HL

PRINTING
TECHNIQUES



SCREEN PRINTING

SUITABLE FOR



FAXES



PHOTOCOPIES



PRINTERS



PAPER

SUSTAINABILITY



IMPRIM'VERT®

BIC
GRAPHIC

BIC®
WRITING INSTRUMENTS

OTHER WRITING
INSTRUMENTS

NOTEBOOKS

BIC® / DIEEP® LIGHTERS
AND BIC® CASES

BIC®
PACKAGING

GENERAL
INFORMATION

See pages 272-276 for a detailed explanation of the icons.

NEW!

1132

BIC® HIGHLIGHTER FLAT
1132



12

Colour ink



10

Colour ink



59

Colour ink



14

Colour ink

1:1 scale



UNDERLINING IN TWO WIDTHS:
Fine 1.2 mm and Large 4.6 mm.

*Water-Based Dye Ink.
Ultra fluorescent ink with up to 95% natural origin.*

BIC® HIGHLIGHTER FLAT

1132

BIC® HIGHLIGHTER FLAT

1132

A BP : full-colour

MOQ 250 units

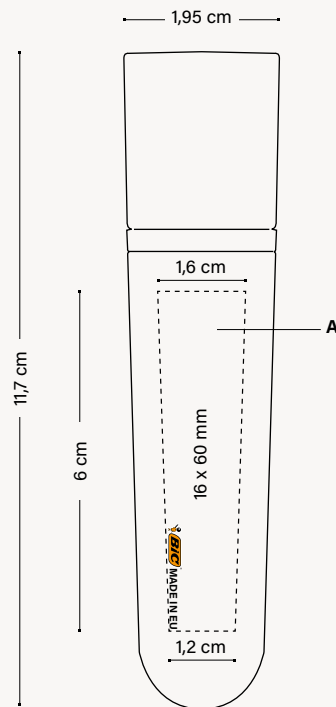

EXTERNAL PACKAGING



WRITING MODES



PRINTING TECHNIQUES



SUSTAINABILITY



BIC GRAPHIC

BIC® WRITING INSTRUMENTS

OTHER WRITING INSTRUMENTS

NOTEBOOKS

BIC® / D'JEEP® LIGHTERS AND BIC® CASES

BIC® PACKAGING

GENERAL INFORMATION

See pages 272-276 for a detailed explanation of the icons.

BIC® VELLEDA® WHITE BOARD MARKER FINE

Velleda®

1651

BIC® VELLEDA® WHITE BOARD MARKER FINE
1651



01/04
●
Colour ink



01/02
●
Colour ink

1/1 scale

1651

BIC® VELLEDA® WHITE BOARD MARKER FINE
1651

A SP: max. 1 col.

MOQ 500 units

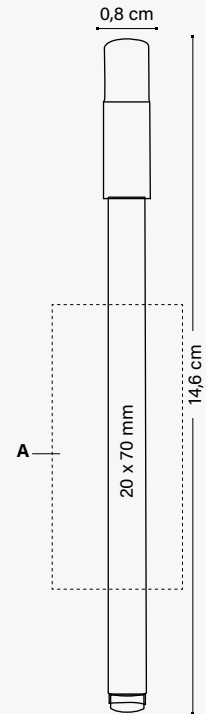

OPTIONAL SPECIAL PACKAGING



MARKING SET

Now you can have it as a set!

+ INFO PAGES 254 TO 265

Can be used as bookmark

EXTERNAL PACKAGING



500 ± 3,2KG



MANUFACTURED AND PRINTED IN BIC FACTORIES



REGULATORY COMPLIANCE



FABRIQUÉ EN FRANCE MADE IN FRANCE



RESISTANT TIP



ISO certified

WRITING MODES



MARKER MK

PRINTING TECHNIQUES



SP SCREEN PRINTING

SUSTAINABILITY



IMPRIM'VERT®



1213

BIC® VELLEDA® WHITE BOARD MARKER GRIP
1213



Textured rubberised grip for more precision and control

01/02
●
Colour ink

1213

BIC® VELLEDA® WHITE BOARD MARKER GRIP
1213

A/B SP: max. 3 col.

MOQ 250 units

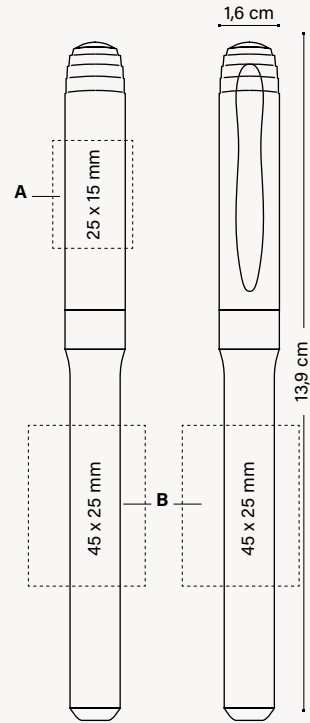

OPTIONAL SPECIAL PACKAGING



MARKING SET

Now you can have it as a set!

+ INFO PAGES 254 TO 265

Can be used as bookmark

EXTERNAL PACKAGING



250 ± 2,7KG



MANUFACTURED AND PRINTED IN BIC FACTORIES



RESISTANT TIP

WRITING MODES



MARKER MK

PRINTING TECHNIQUES



SCREEN PRINTING

SUSTAINABILITY



BIC® MARK-IT PERMANENT MARKER

1214

**BIC® MARK-IT
PERMANENT
MARKER**
1214



01/02
●
Colour ink

01/04
●
Colour ink

1:1 scale

←
*Textured rubberised
grip for more
precision and control*

1214

**BIC® MARK-IT
PERMANENT MARKER**
1214

A/B SP: max. 3 col.

MOQ 250 units

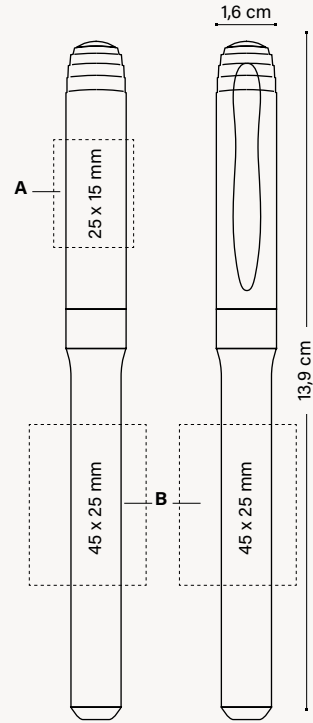

OPTIONAL SPECIAL PACKAGING



MARKING
SET

*You can have
it as a set!*

+ INFO PAGES 254 TO 265

*Can be used
as bookmark*

EXTERNAL PACKAGING



250 ± 2,8KG



MANUFACTURED
AND PRINTED IN
BIC FACTORIES



RESISTANT
TIP

WRITING MODES



MARKER
MK

PRINTING TECHNIQUES



SCREEN
PRINTING

SUSTAINABILITY



BIC® PERMANENT MARKER ECOLUTIONS®

ecolutions



*Excluding ink system

MADE FROM **52% RECYCLED MATERIAL***

Add the Möbius loop to your artwork at no additional charge. Please specify "Print the Möbius loop" on your order. (Möbius loop imprint defaults to left-hand hand corner.)



PHARMACEUTICAL WASTE

1210

BIC® PERMANENT MARKER
ecolutions® 1210

A SP: max. 1 col.

MOQ 250 units

1210

BIC® PERMANENT MARKER
ecolutions® 1210



1:1 scale

02

Colour ink

02

Colour ink

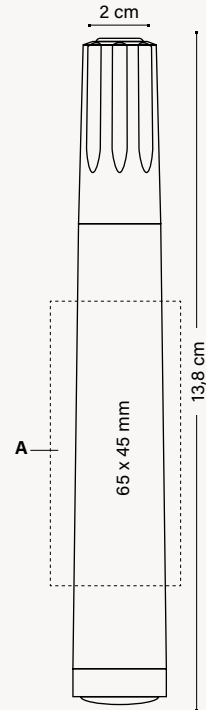

EXTERNAL PACKAGING



MANUFACTURED AND PRINTED IN BIC FACTORIES

REGULATORY COMPLIANCE

FABRIQUÉ EN FRANCE MADE IN FRANCE



RESISTANT TIP



WRITING MODES



MARKER MK

PRINTING TECHNIQUES



SCREEN PRINTING

SUSTAINABILITY



PHARMACEUTICAL WASTE



ecolutions®

*The percentage is calculated on total weight of product excluding ink system. Due to the recycled content of the raw materials used to make the product, we cannot guarantee that the colours shown in the catalogue or colours customised to order will always have the same colour and appearance.

BIC® MECHANICAL PENCILS

Stay sharp with these first-class
mechanical pencils!
They're solid and resistant.

FR/

**Toujours prêts avec ces porte-mines
de grande qualité.**

Ils sont solides et leurs mines sont résistantes.

DE/

**Stets schreibbereit mit diesen
Qualitäts-Druckbleistiften.**

Solide und resistent.

IT/

**Sempre pronti con i nostri portamine
di qualità superiore.**

Sono solidi e resistenti.

ES/

**Siempre preparados con estos
portaminas de calidad superior.**

Son sólidos y resistentes.

Always Sharp

BIC® MECHANICAL PENCILS FAMILY



1120
BIC® Matic®
Opaque



1028
BIC® Media Clic
Mechanical Pencil Opaque



1028
BIC® Media Clic
Mechanical Pencil Frosted



1021
BIC® Media Clic Grip
Mechanical Pencil Frosted



1E21
BIC® Media Clic Grip Ecolutions®
Mechanical Pencil Opaque

BIC
GRAPHIC

BIC®
WRITING INSTRUMENTS

OTHER WRITING
INSTRUMENTS

NOTEBOOKS

BIC® / DIEEP® LIGHTERS
AND BIC® CASES

BIC®
PACKAGING

GENERAL
INFORMATION

1120

BIC® MATIC®
1120 Opaque



**The percentage is calculated based on the total weight of the mechanical pencil excluding lead. Due to the recycled content of the raw materials used to make the product, we cannot guarantee that the colours shown in the catalogue or colours customised to order will always have the same colour and appearance.*

1120

BIC® MATIC®
1120

A SP: max. 1 col.
B/C: max. 2 col.

MOQ 500 units

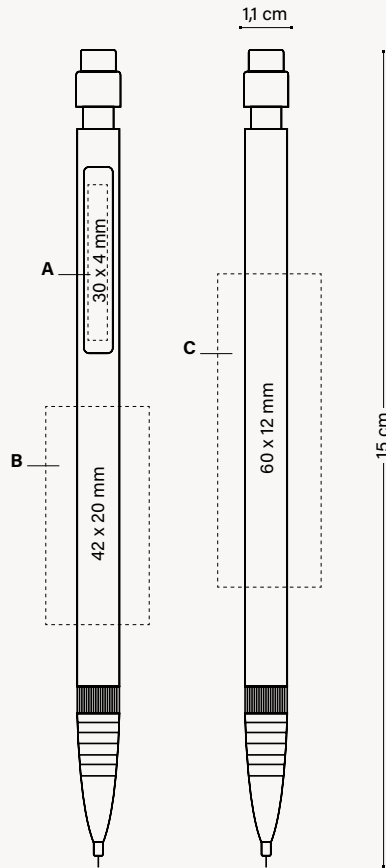

OPTIONAL SPECIAL PACKAGING



PLASTIC
POUCH

+ INFO PAGES 254 TO 265

*Can be used
as bookmark*

EXTERNAL PACKAGING



500 ± 3,1 KG



WRITING MODES



MECHANICAL PENCIL MP
Ø 0,7 MM

PRINTING TECHNIQUES



SCREEN PRINTING

SUSTAINABILITY



BIC® MEDIA CLIC MECHANICAL PENCIL

1028  *Iconic BIC® Boy is embossed*

BIC® MEDIA CLIC
1028 Mechanical pencil
Opaque



1/1 scale

5C

1028

BIC® MEDIA CLIC
1028 Mechanical pencil
Frosted



1/1 scale

39

BIC® MEDIA CLIC GRIP MECHANICAL PENCIL

ECO version and standard at the same price!

ecolutions®

MADE FROM **98% RECYCLED MATERIAL***
*From barrel

98%

PLASTIC CAR PARTS

1021

BIC® MEDIA CLIC GRIP
1021 Mechanical pencil
Frosted



1E21

BIC® MEDIA CLIC GRIP
ecolutions® 1E21 Mechanical pencil
Opaque



* The percentage is calculated based on total weight of the barrel. Due to the recycled content of the raw materials used to make the product, we cannot guarantee that the colours shown in the catalogue or colours customised to order will always have the same colour and appearance.

BIC® MEDIA CLIC MECHANICAL PENCIL

1028

BIC® MEDIA CLIC
1028 Mechanical pencil

1021 / 1E21

BIC® MEDIA CLIC GRIP
1021 Mechanical pencil
ecolutions® 1E21 Mechanical pencil

MIX & MATCH No extra charge

MOQ 500 units
Standard colours combination

Clip



Opaque

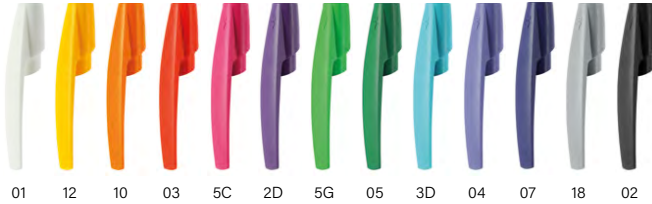

Frosted



01 12 10 03 5C 2D 5G 05 3D 04 07 18 02 69

Barrel



Opaque



5C

Frosted



39

Barrel & Grip

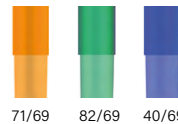

71/69 82/69 40/69

britePix DIGITAL THE SOLUTION FOR FULL COLOUR COMMUNICATION!

ecolutions®



Standard colours combination*

Barrel & Grip

Opaque

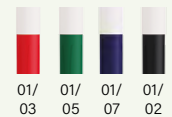

01/03 01/05 01/07 01/02



*From barrel
Add the Möbius loop to your artwork at no additional charge. Please specify "Print the Möbius loop" on your order. (Möbius loop imprint defaults to left-hand corner.)

All colour range available in Digital britePix™

Exact colour match: ≥ 10.000 units 1028
Exact colour match: ≥ 20.000 units 1021 / 1E21



MIX & MATCH

MANUFACTURED AND PRINTED IN BIC FACTORIES

PERSONALISED COLOURS

ISO certified

WRITING MODES

MECHANICAL PENCIL MP

PRINTING TECHNIQUES

SP SCREEN PRINTING

DG DIGITAL

SUSTAINABILITY

ecolutions® PLASTIC CAR PARTS

See pages 274-277 for a detailed explanation of the icons. *Due to the recycled content of the raw materials used to make the product, we cannot guarantee that the colours shown in the catalogue or colours customised to order will always have the same colour and appearance.

BIC® MEDIA CLIC MECHANICAL PENCIL

1028

BIC® MEDIA CLIC

1028 Mechanical pencil
A SP: max. 4 col.
B SP: max. 2 col.
C DG: full-colour

MOQ 500 units.

1021 / 1E21

BIC® MEDIA CLIC GRIP

1021 Mechanical pencil
ecolutions® 1E21 Mechanical pencil
D SP: max. 4 col.
E SP: max. 2 col.
F DG: full-colour

MOQ 500 units.

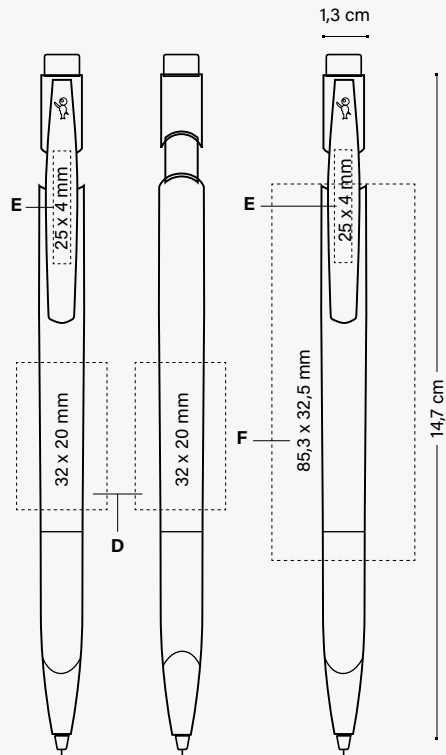
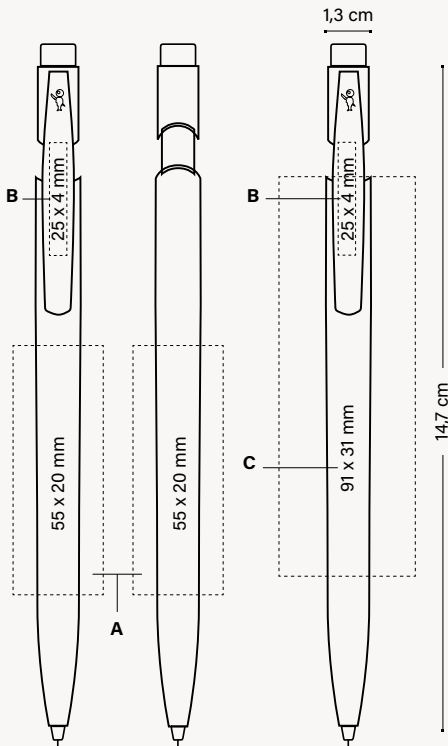

OPTIONAL SPECIAL PACKAGING



ECO SLEEVE



PLASTIC POUCH



WINDOW BOX

+ INFO PAGES 254 TO 265

Can be used as bookmark

EXTERNAL PACKAGING



500 ± 4,1 KG

OPTIONAL SPECIAL PACKAGING



ECO SLEEVE



PLASTIC POUCH



WINDOW BOX

+ INFO PAGES 254 TO 265

Can be used as bookmark

EXTERNAL PACKAGING



500 ± 4,3 KG



MANUFACTURED AND PRINTED IN BIC FACTORIES



MADE IN SPAIN

WRITING MODES



MECHANICAL PENCIL MP

PRINTING TECHNIQUES



SCREEN PRINTING



DIGITAL

SUSTAINABILITY



PLASTIC CAR PARTS

See pages 272-276 for a detailed explanation of the icons.

BIC® PENCILS & BIC® KIDS EVOLUTION® COLOURING SET

Graphite and colouring pencils made from synthetic resin and wood-free, that will not splinter in the event of breaking.

FR/

Crayons BIC® et BIC® Kids Evolution® Colouring set.

Crayons de graphite et de couleur fabriqués en résine synthétique et sans bois, qui ne font pas d'écharde en cas de brisure.

DE/

BIC® Bleistifte und BIC® Kids Evolution® Colouring Set.

Graphit- und Farbstifte aus synthetischem Harz und ohne Holz, die bei Bruch nicht splintern.

IT/

Matite BIC® e BIC® Kids Evolution® Colouring set.

Matite di grafite e colorate realizzate in resina sintetica e senza legno, che non scheggiano in caso di rottura.

ES/

Lápices BIC® y BIC® Kids Evolution® Colouring set.

Lápices de grafito y de colores fabricados con resina sintética y sin madera, que no se astillan en caso de romperse.





1150
Graphite Pencil
Cut end Ecolutions®



1151
Graphite Pencil
With eraser Ecolutions®

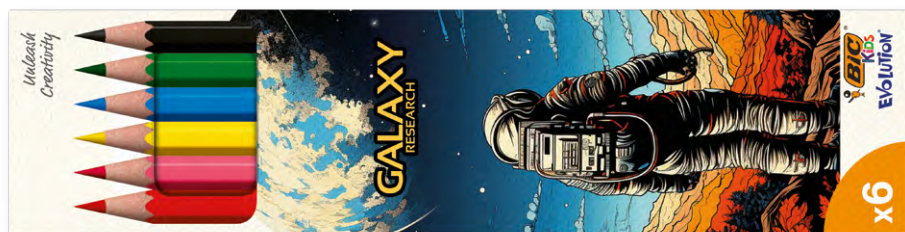

1607
BIC® Kids Evolution®
Colouring set Ecolutions®



53062
Sprout™ Graphite Pencil

Evolution® eColutions®

britePix DIGITAL THE SOLUTION FOR FULL COLOUR COMMUNICATION!

britePix DIGITAL THE SOLUTION FOR FULL COLOUR COMMUNICATION!

 Embossed iconic BIC® brand!



MADE FROM 64% RECYCLED MATERIAL*



FRIDGES AND YOGURT POTS



MADE FROM 52% RECYCLED MATERIAL*



FRIDGES AND YOGURT POTS

1150

GRAPHITE PENCIL CUT END
eColutions® 1150

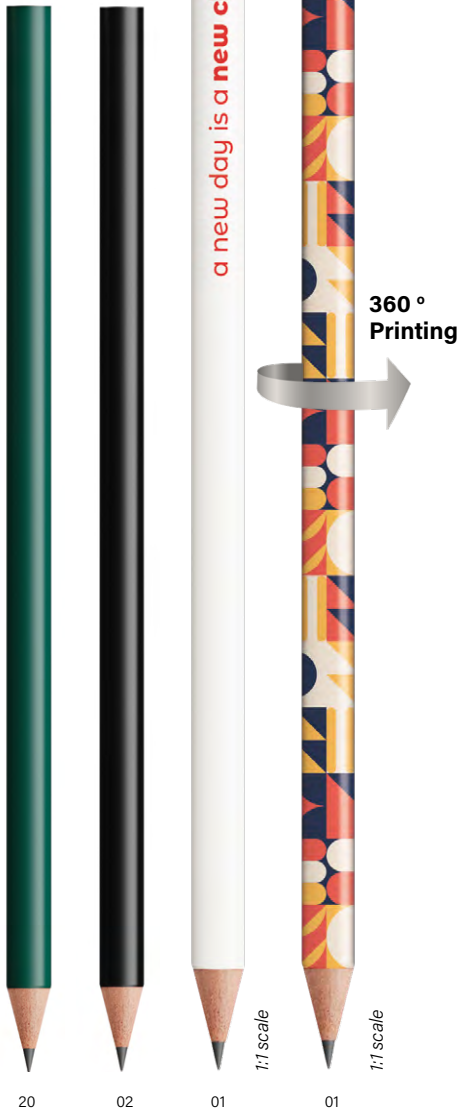

1151

GRAPHITE PENCIL WITH ERASER
eColutions® 1151

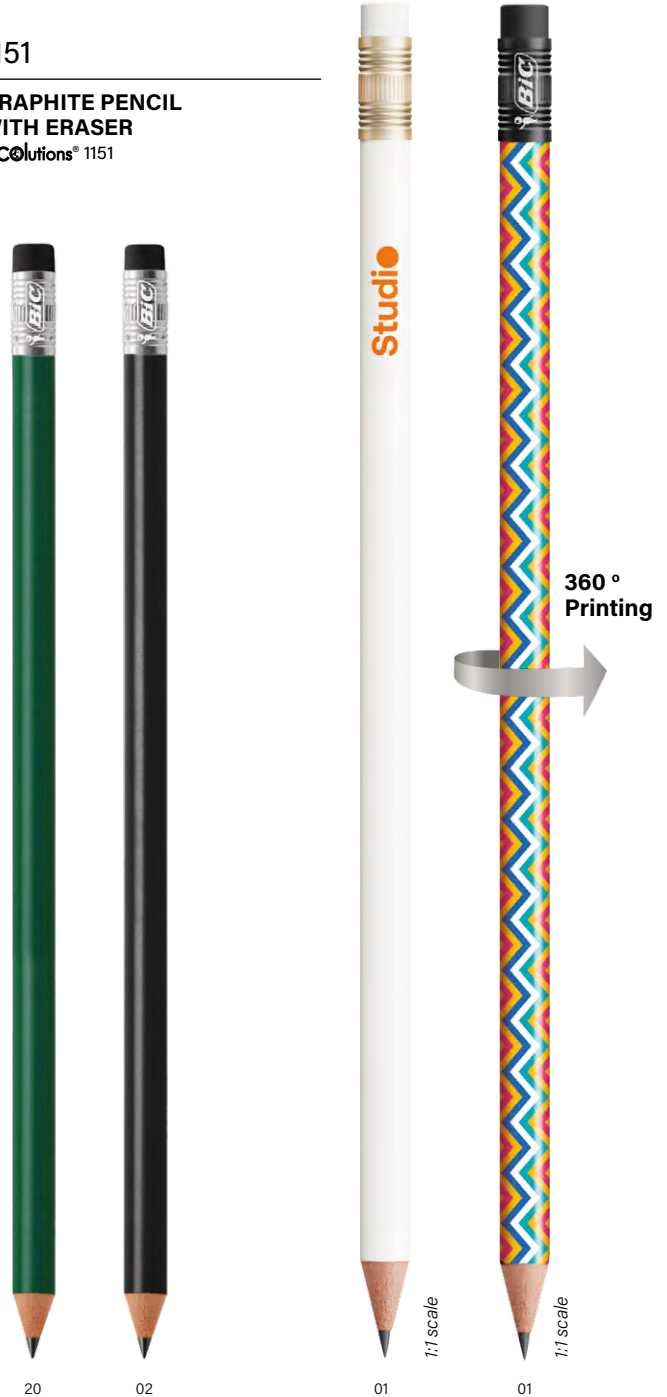

*The percentage is calculated based on total weight of the product. Due to the recycled content of the raw materials used to make the product, we cannot guarantee that the colours shown in the catalogue or colours customised to order will always have the same colour and appearance.



MADE FROM UP TO
64% RECYCLED MATERIAL*



Add the Möbius loop to your artwork at no additional charge. Please specify it on your order. (Möbius loop imprint defaults to left-hand hand corner.)**

1150 / 1151

GRAPHITE PENCIL

1150 / 1151

MIX & MATCH No extra charge

MOQ 500 units
Standard colours combination

Eraser

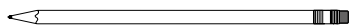

Opaque



Ferrule

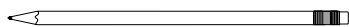

Opaque



Barrel



Opaque

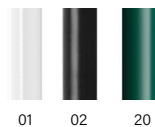

MIX & MATCH



MANUFACTURED AND PRINTED IN BIC FACTORIES

FABRIQUÉ EN FRANCE

MADE IN FRANCE



REGULATORY COMPLIANCE



ISO certified



RESISTANT TIP



NO SPLINTER



PROTECTIVE SHEATH



EASY TO USE AND ERASE

WRITING MODES



PENCIL PC HB 0,2,3MM

PRINTING TECHNIQUES



SCREEN PRINTING



DIGITAL

SUSTAINABILITY



See pages 272-276 for a detailed explanation of the icons.

**Percentage indicated in the Möbius loop depend on the product selected (1150 or 1151). Please, see details at the product description.



1150

BIC® EVOLUTION® ECOLUTIONS®
eColutions® 1150 (Pencil cut end)

A SP: max. 1 col.

MOQ 500 units

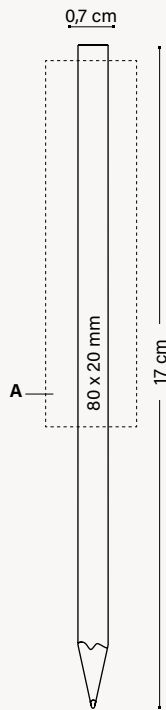

1151

BIC® EVOLUTION® ECOLUTIONS®
eColutions® 1151 (Pencil with eraser)

MOQ 500 units

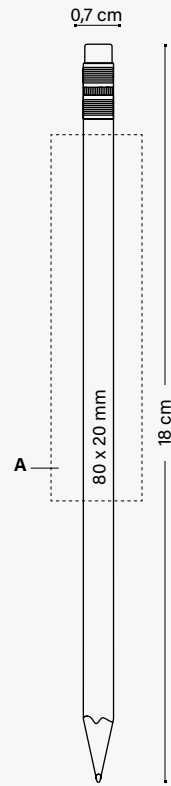

OPTIONAL SPECIAL PACKAGING



+ INFO PAGES 254 TO 265

*Can be used
as bookmark*

EXTERNAL PACKAGING



1150

BIC® EVOLUTION® ECOLUTIONS®
ecolutions® 1150 (Pencil cut end Digital)

A DG: full-colour (area for images)

MOQ 500 units

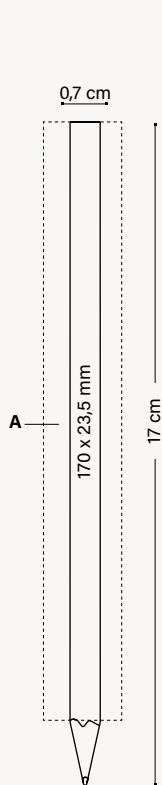

1151

BIC® EVOLUTION® ECOLUTIONS®
ecolutions® 1151 (Pencil with eraser Digital)

MOQ 500 units

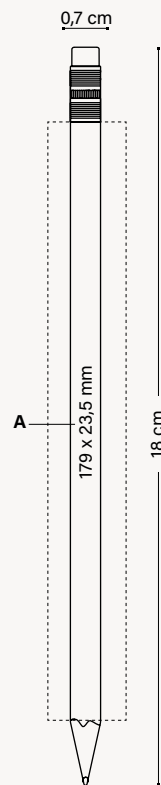

OPTIONAL SPECIAL PACKAGING



PLASTIC POUCH (X 3 UNITS)

+ INFO PAGES 254 TO 265

Can be used as bookmark

EXTERNAL PACKAGING



500 ± 3,5 KG



MADE IN FRANCE



WRITING MODES



PRINTING TECHNIQUES



SUSTAINABILITY



BIC GRAPHIC

BIC® WRITING INSTRUMENTS

OTHER WRITING INSTRUMENTS

NOTEBOOKS

BIC® / DEEP® LIGHTERS AND BIC® CASES

BIC® PACKAGING

GENERAL INFORMATION

See pages 272-276 for a detailed explanation of the icons.

BIC® KIDS EVOLUTION® COLOURING SET



Ultra-resistant Wood-free pencils that are easy to sharpen.
Ideal for everyday drawing and colouring.

FABRIQUÉ
EN FRANCE
MADE IN FRANCE



Safe usage
for kids

- Does not splinter on breaking
- Resistant to chewing

Fully customisable
cardboard box**



*Excluding lead

MADE FROM
51% RECYCLED MATERIAL*



FRIDGES AND
YOGURT POTS

1607

BIC® KIDS EVOLUTION® COLOURING SET
6 UNITS
eColutions® 1607

NEW!



1609

BIC® KIDS EVOLUTION® COLOURING SET
12 UNITS
eColutions® 1609



*The percentage is calculated based on the total weight of the pencil excluding lead.

**Non-personalisable pencils

BIC® KIDS EVOLUTION® COLOURING SET

1607

BIC® KIDS EVOLUTION® COLOURING SET
ecolutions® 1607

A DG: full-colour
 MOQ 500 units.

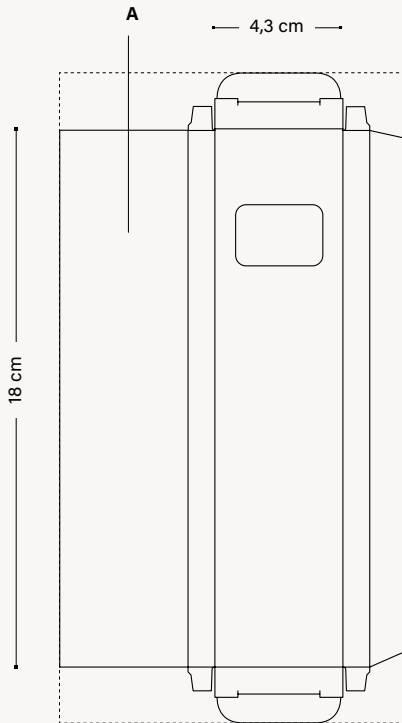

EXTERNAL PACKAGING



100 ± 3,74 KG

1609

BIC® KIDS EVOLUTION® COLOURING SET
ecolutions® 1609

A DG: full-colour
 MOQ 500 units.

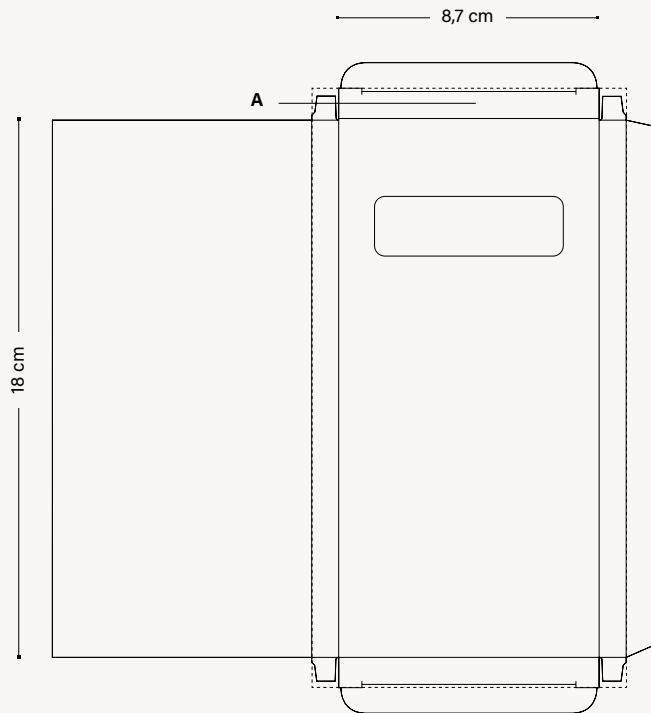

EXTERNAL PACKAGING



100 ± 7,35 KG



MANUFACTURED AND PRINTED IN BIC FACTORIES



MADE IN FRANCE



REGULATORY COMPLIANCE



RESISTANT TIP



NO SPLINTER



PROTECTIVE SHEATH

WRITING MODES



COLOURING PENCIL Ø 3,05MM

SUSTAINABILITY



FRIDGES AND YOGURT POTS

BIC GRAPHIC

BIC® WRITING INSTRUMENTS

OTHER WRITING INSTRUMENTS

NOTEBOOKS

BIC® / DEEPP® LIGHTERS AND BIC® CASES

BIC® PACKAGING

GENERAL INFORMATION

See pages 272-276 for a detailed explanation of the icons.

SPROUT™ GRAPHITE PENCIL



The sustainable pencil that you can plant after use and grow into herbs, vegetables, fruits or flowers. This pencil enables you to convey a meaningful message and sets the foundation for a lasting relationship.

FR
Le crayon durable que vous pouvez planter après son utilisation et faire pousser des plantes, des légumes, des fruits ou des fleurs.

DE
Der nachhaltige Bleistift kann nach Gebrauch eingepflanzt werden, um sich in Kräuter, Obst, Gemüse oder Blumen zu verwandeln. Dieser Stift ermöglicht es Ihnen, tiefgreifende Botschaften zu übermitteln und legt den Grundstein für dauerhafte Beziehungen.

IT
La matita sostenibile che può essere piantata dopo essere stata utilizzata e cresce come un'erba, un vegetale, un frutto o un fiore.

ES
El lápiz sostenible que puedes plantar después de ser utilizado y crece como una hierba, un vegetal, una fruta o una flor.

53062

SPROUT™ GRAPHITE PENCIL 53062

Contains seeds

FR/ contient des graines
DE/ enthält Samen
IT/ contiene semi
ES/ contiene semillas

Plant after use and make it sprout



FR/ Plantez après utilisation et faites-le germer.
DE/ Pflanze nach Gebrauch und lass sie sprießen.
IT/ Piantalo dopo l'uso e fallo germogliare.
ES/ Plántalo después de usarlo y haz que brote.



Standard cardboard!

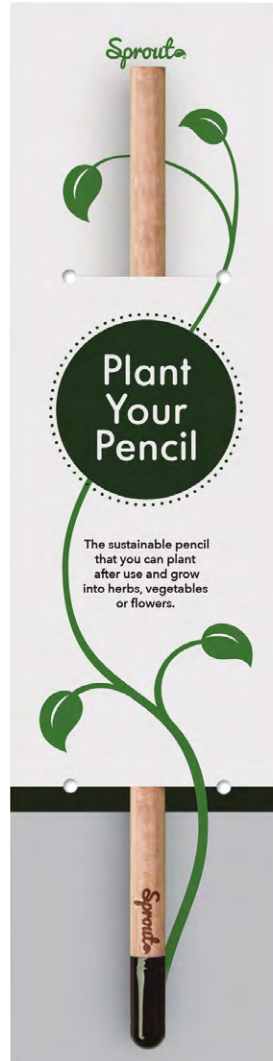

Standard cardboard packaging

Customisable cardboard!

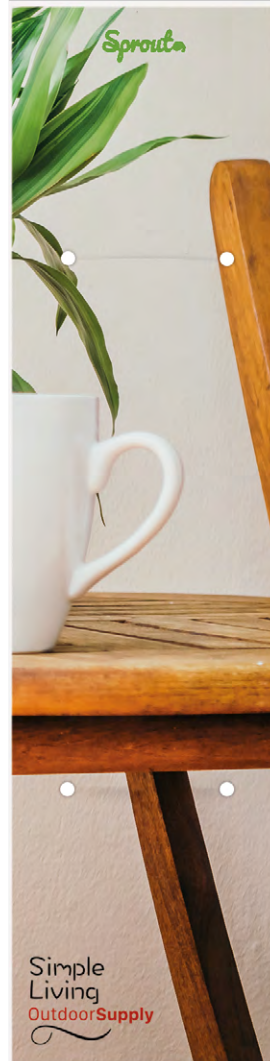

Personalised cardboard packaging



Rear side



Graphite Lead

FR/ Mine de graphite.
DE/ Graphitmine
IT/ Mina di grafite.
ES/ Mina de grafito.

Once the pencil is too short to write with, plant the stub and watch your message turn into a pot of beautiful herbs, flowers, fruits or vegetables. **Choose between 9 different seeds!**

FR/ Une fois que le crayon est trop court pour écrire, plantez-le et regardez votre message se transformer en un pot de belles herbes, fleurs, fruits ou légumes. **Choisissez parmi 9 graines différentes!**

DE/ Sobald der Bleistift zu kurz zum Schreiben ist, pflanze den Stummel ein und beobachte, wie sich deine Botschaft in einen Topf mit schönen Kräutern, Blumen, Früchten oder Gemüse verwandelt. **Wähle zwischen 9 verschiedenen Samen!**

IT/ Quando la matita è troppo corta per scrivere, pianta il mozzicone e guarda il tuo messaggio trasformarsi in un vaso di bellissime erbe aromatiche, fiori, frutta o verdura. **Scegli tra 9 diversi semi!**

ES/ Cuando el lápiz sea demasiado corto para escribir, planta el trozo que queda y observa cómo tu mensaje se convierte en una maceta llena de hermosas hierbas, flores, frutas o verduras. **¡Elige entre 9 semillas diferentes!**

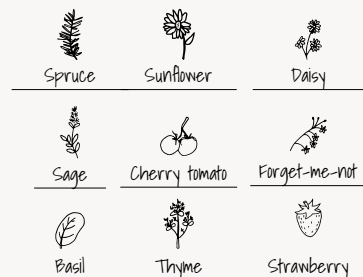

SPROUT™ GRAPHITE PENCIL

53062

SPROUT™ GRAPHITE PENCIL

53062

A LE
B DG

MOQ 100 units



Pencil sharpening is offered at an extra charge

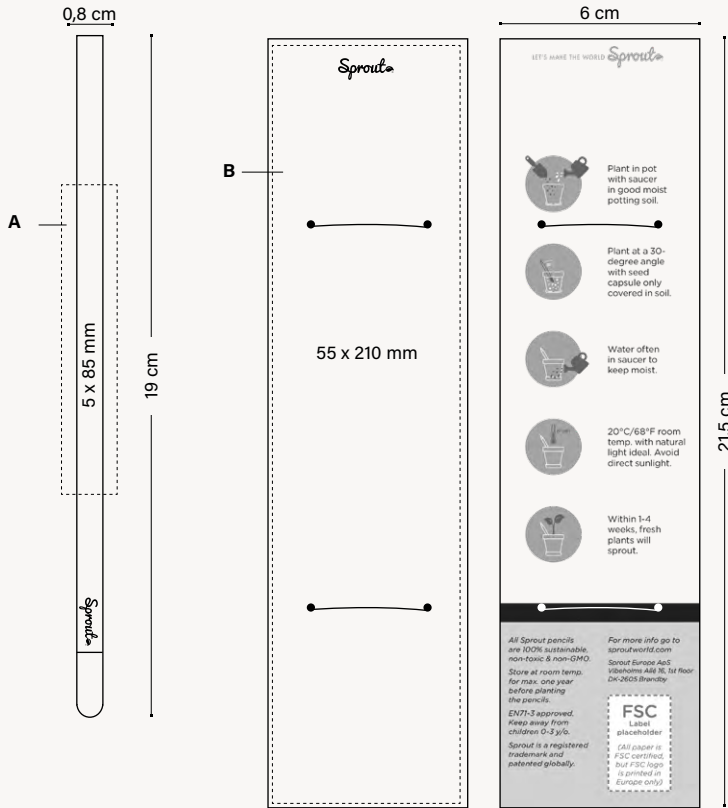

EXTERNAL PACKAGING



Sprout™ Graphite Pencil without cardboard:

500 ± 2,37 KG

Sprout™ Graphite Pencil with cardboard:

100 ± 0,92 KG

PACKAGING



FOREST STEWARDSHIP COUNCIL



Sprout™



WRITING MODES



PENCIL PC HB
Ø 2,3MM

PRINTING TECHNIQUES



LASER



DIGITAL

SUSTAINABILITY



FSC AND RECYCLABLE CARDBOARD

BIC GRAPHIC

BIC® WRITING INSTRUMENTS

OTHER WRITING INSTRUMENTS

NOTEBOOKS

BIC® / DEEPP® LIGHTERS AND BIC® CASES

BIC® PACKAGING

GENERAL INFORMATION

Please consult your sales representative for details on language availability.

FR/ Veuillez consulter votre représentant commercial pour plus de détails sur les langues disponibles.
DE/ Bitte wenden Sie sich an Ihren Vertriebsmitarbeiter, um Einzelheiten zur Verfügbarkeit von Sprachen zu erfahren.
IT/ Per ulteriori dettagli sulla disponibilità delle lingue, si prega di consultare il proprio rappresentante commerciale.
ES/ Consulte a su representante de ventas para obtener más información sobre la disponibilidad de idiomas.



CHECK OUT THE VIDEO

See pages 272-276 for a detailed explanation of the icons.

OTHER WRITING INSTRUMENTS

02

PLASTIC PENS

Reliable simplicity for everyday writing.

Lightweight and practical, these plastic pens combine functionality and comfort while meeting our quality standards. Choose the option that best suits your brand or style.

FR/

Fiabilité au quotidien, style sans effort.

Notre collection de stylos en plastique allie fonctionnalité, confort et design moderne. Légers mais résistants. Choisissez parmi une large gamme de couleurs et de finitions pour trouver celui qui correspond parfaitement à votre marque ou à votre style personnel.

DE/

Zuverlässigkeit im Alltag, müheloser Stil.

Unsere Kollektion an Kunststoffstiften vereint Funktionalität, Komfort und modernes Design. Leicht und dennoch strapazierfähig. Wählen Sie aus einer großen Auswahl an Farben und Oberflächen, um die perfekte Ergänzung für Ihre Marke oder Ihren persönlichen Stil zu finden.

IT/

Affidabilità quotidiana, stile senza sforzo.

La nostra collezione di penne in plastica combina funzionalità, comfort e design moderno. Leggere ma resistenti. Scegli tra un'ampia gamma di colori e finiture per trovare quella perfetta per il tuo marchio o il tuo stile personale.

ES/

Fiabilidad diaria, estilo sin esfuerzo.

Nuestra colección de bolígrafos de plástico combina funcionalidad, comodidad y diseño moderno. Ligeros pero resistentes. Elije entre una amplia gama de colores y acabados para encontrar el que mejor se adapte a tu marca o estilo.



12010
Basic Pen



11748
Click Pen



11243
Striped Grip Pen

Simple and
practical choice

BASIC PEN

12010

BASIC PEN

12010

Colour ink



BASIC PEN

12010

BASIC PEN
12010

A/B SP: max. 1 col.

MOQ 500 units

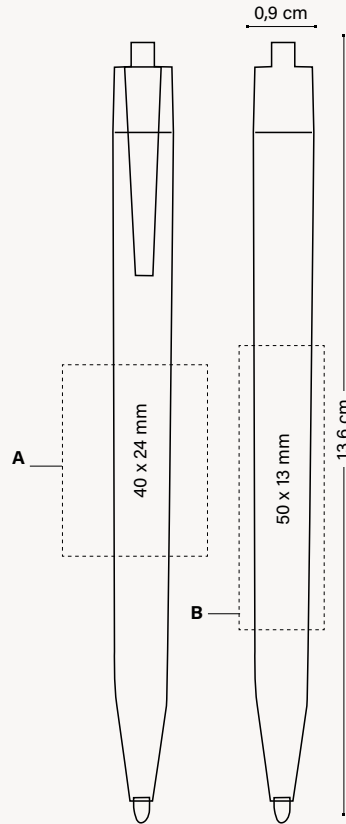

EXTERNAL PACKAGING



WRITING MODES



PRINTING TECHNIQUES



SUSTAINABILITY



BIC GRAPHIC

BIC WRITING INSTRUMENTS

OTHER WRITING INSTRUMENTS

NOTEBOOKS

BIC / DIEP LIGHTERS AND BIC CASES

BIC PACKAGING

GENERAL INFORMATION

See pages 272-276 for a detailed explanation of the icons.

CLICK PEN

11748

CLICK PEN

11748

Colour ink



1:1 scale

CLICK PEN

11748

CLICK PEN
11748

A/B SP: max. 4 col.
C/D PD: max. 4 col.

MOQ 500 units

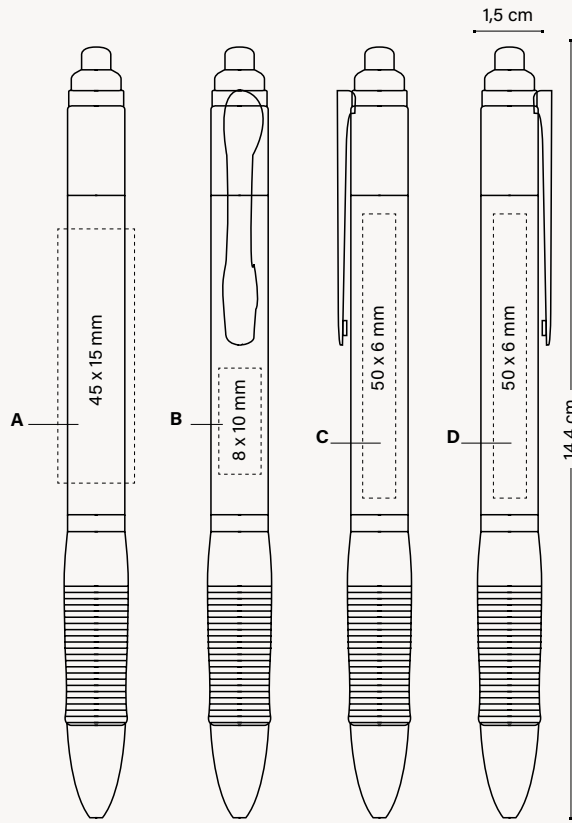

EXTERNAL PACKAGING



1000 ± 9,5 KG



WRITING MODES



PRINTING TECHNIQUES



SUSTAINABILITY



BIC GRAPHIC

BIC WRITING INSTRUMENTS

OTHER WRITING INSTRUMENTS

NOTEBOOKS

BIC / DIEP LIGHTERS AND BIC CASES

BIC PACKAGING

GENERAL INFORMATION

See pages 272-276 for a detailed explanation of the icons.

STRIPED GRIP PEN

11243

STRIPED GRIP PEN

11243

Colour ink
●



10

03

24

8C

04

1:1 scale

STRIPED GRIP PEN

11243

STRIPED GRIP PEN

11243

A SP: max. 2 col.

B PD: max. 1 col.

MOQ 500 units

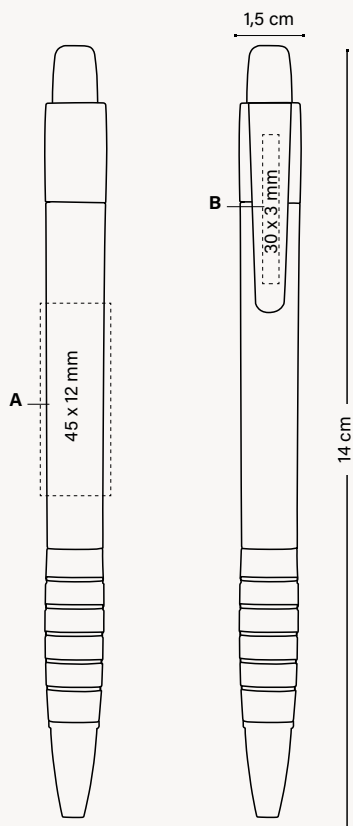

EXTERNAL PACKAGING



WRITING MODES



PRINTING TECHNIQUES



SUSTAINABILITY



BIC®
GRAPHIC

BIC®
WRITING INSTRUMENTS

OTHER WRITING
INSTRUMENTS

NOTEBOOKS

BIC® / DIEEP® LIGHTERS
AND BIC® CASES

BIC®
PACKAGING

GENERAL
INFORMATION

See pages 272-276 for a detailed explanation of the icons.

SLEEK STYLUS PEN

A pen for every professional moment.

Confident writing for every signature..

FR/

Un stylo pour chaque moment professionnel.

Une écriture assurée pour chaque signature.

DE/

Ein Stift für jeden professionellen Moment.

Sicheres Schreiben für jede Unterschrift.

IT/

Una penna per ogni momento professionale.

Scrittura sicura per ogni firma.

ES/

Un bolígrafo para cada momento profesional.

Escritura segura para cada firma.

SLEEK STYLUS PEN FAMILY



11666
Sleek Stylus Pen



11747
Sleek Stylus
Matt Pen



11976
Sleek Stylus
Executive Pen

Write Boldly

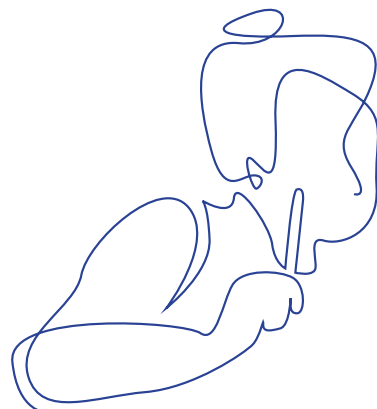

SLEEK STYLUS PEN

11666

SLEEK STYLUS PEN

11666

Colour ink



01

1:1 scale

11747

SLEEK STYLUS MATT PEN

11747

Colour ink



47



04

1:1 scale

11976

SLEEK STYLUS EXECUTIVE PEN

11976



26

Available in blue ink



2N

Available in black ink

1:1 scale

SLEEK STYLUS PEN

11666 / 11747 / 11976

SLEEK STYLUS PEN

11666

SLEEK STYLUS MATT PEN

11747

SLEEK STYLUS EXECUTIVE PEN

11976

A SP: max. 1 col.

B SP: max. 2 col.

C LE

MOQ 500 units (SP)

MOQ 100 units (LE)

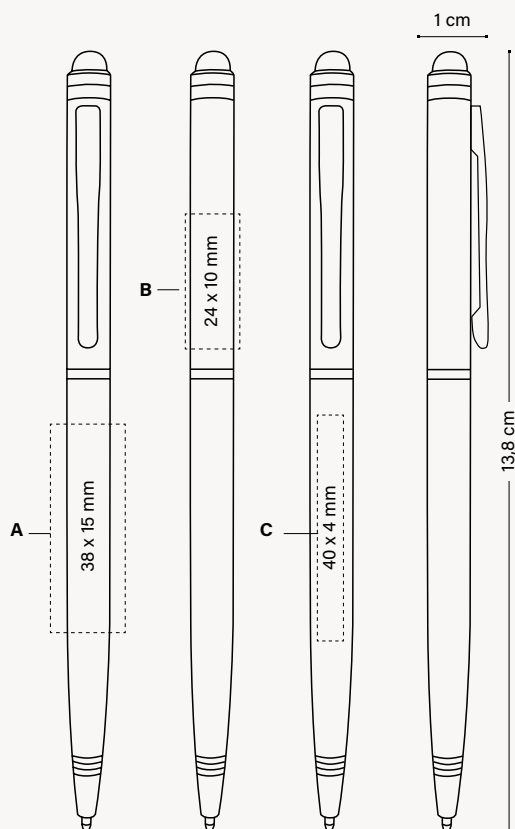

EXTERNAL PACKAGING



(11666)
900 ± 12,4 KG



(11747 / 11976)
800 ± 13 KG



WRITING MODES



PRINTING TECHNIQUES



SUSTAINABILITY



BIC® GRAPHIC

BIC® WRITING INSTRUMENTS

OTHER WRITING INSTRUMENTS

NOTEBOOKS

BIC® / DIEEP® LIGHTERS AND BIC® CASES

BIC® PACKAGING

GENERAL INFORMATION

See pages 272-276 for a detailed explanation of the icons.

NOTEBOOKS

03

BIC® PARTNER NOTEBOOKS



BIC® PARTNER: a high-quality,
Made in Italy notebook that goes
wherever your ideas take you.

FR/
BIC® PARTNER : un carnet de haute qualité, fabriqué en
Italie, qui vous accompagne partout où vos idées vous
mènent.

DE/
BIC® PARTNER: ein hochwertiges Notizbuch, hergestellt
in Italien, das Sie überall hin begleitet, wohin Ihre Ideen
Sie führen.

IT/
BIC® PARTNER: un taccuino di alta qualità, prodotto in
Italia, che ti accompagna ovunque ti portino le tue idee.

ES/
BIC® PARTNER: una libreta de alta calidad, fabricada en
Italia, que te acompaña allí donde te lleven tus ideas.

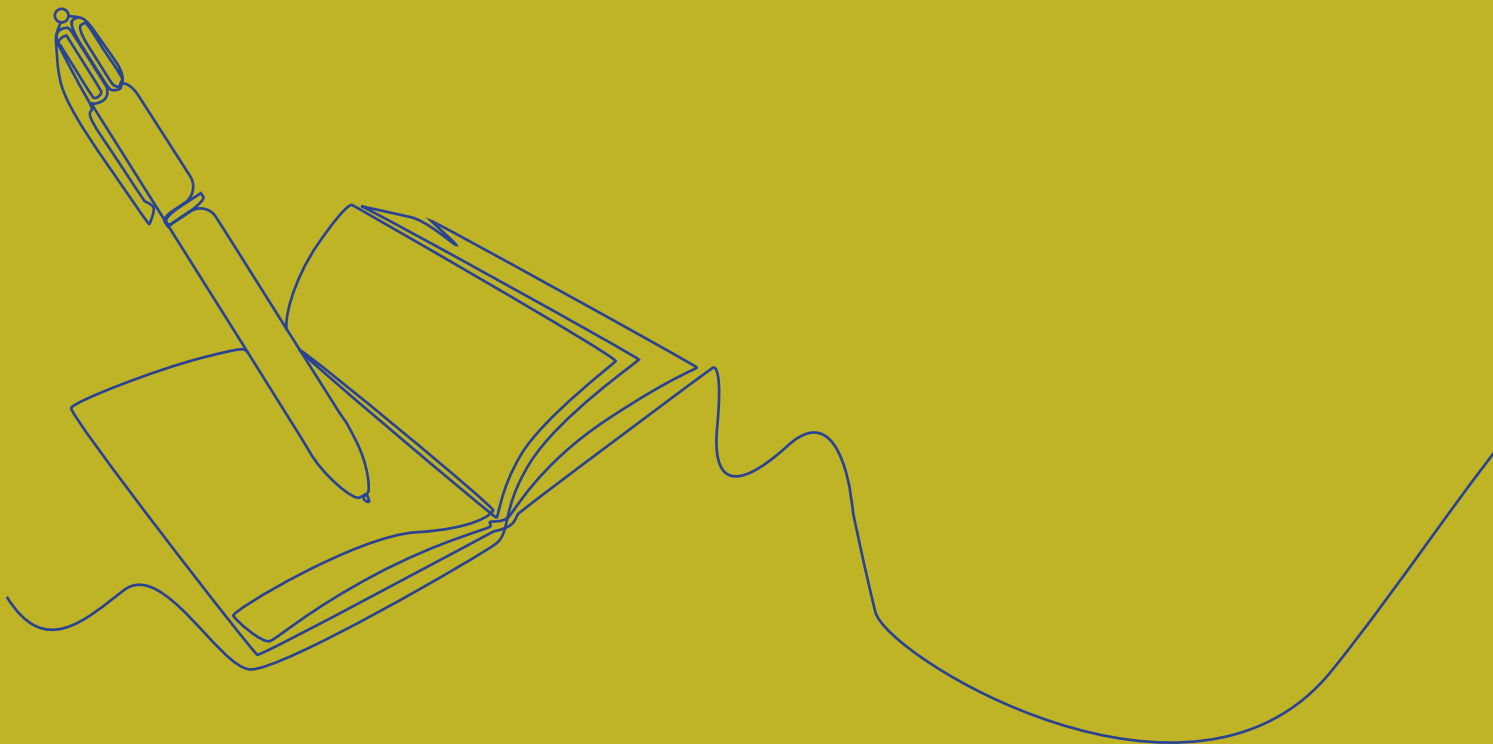

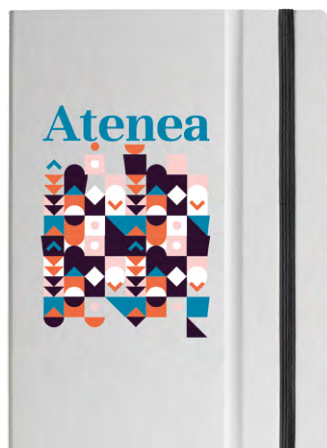

3709
BIC® Partner Hard Cover*

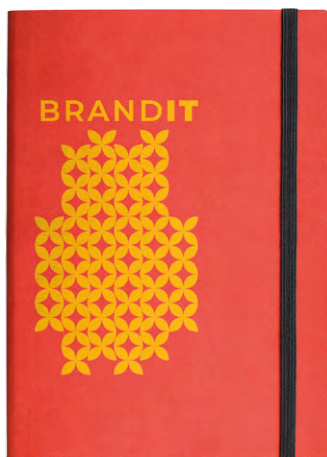

3710
BIC® Partner Flex Cover*



3711
BIC® Partner FruitCover*

* Pen not included.
FR/ * Stylo non inclus. DE/ * Stift nicht enthalten. IT/ * Penna non inclusa. ES/ * Bolígrafo no incluido.

3709

BIC® PARTNER HARD COVER
3709

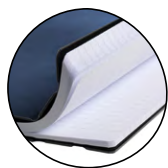

Equipped with our **Quickview system** that allows for easy consultation.

FR/ Équipé d'un système Quickview permettant une consultation facile.

DE/ Ausgestattet mit einem Quickview-System, das eine einfache Einsicht ermöglicht.

IT/ Dotato del sistema Quickview che permette una consultazione semplice.

ES/ Equipada con el sistema Quickview que permite una fácil consulta.

DIN A5
72 sheets / 144 pages



01
White



02
Black



07
Blue Navy



03
Red



High-quality, recycled, FSC-certified paper

FR/ Papier de haute qualité, recyclé et certifié FSC.
DE/ Hochwertiges, recyceltes, FSC-zertifiziertes Papier.
IT/ Carta di alta qualità, riciclata e certificata FSC.
ES/ Papel de alta calidad, reciclado y certificado por el FSC.



Elastic closure

FR/ Fermeture élastique.
DE/ Elastischer Verschluss.
IT/ Chiusura elastica.
ES/ Cierre elástico.



Internal pocket

FR/ Poche intérieure.
DE/ Innentasche.
IT/ Tasca interna.
ES/ Bolsillo interior.

Pen not included

FR/ Stylo non inclus.

DE/ Stift nicht enthalten.

IT/ Penna non inclusa.

ES/ Bolígrafo no incluido.

BIC® PARTNER HARD COVER

3709

BIC® PARTNER HARD COVER

3709

A SP: max. 1 col.





B BP: full-colour

C/D HS/DB: max. 1 col.

MOQ 25 units

BIC® Partner Hard Cover contain FSC Certified White Paper, 80 g/m², with no artificial coating, made from eucalyptus cellulose, short fibre, with an excellent wrapping and high whiteness.

 LINED PAPER

 Black  Blue  White  Red

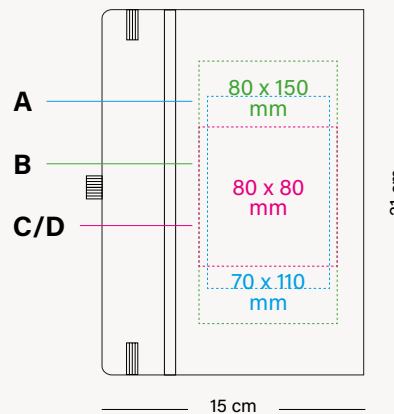
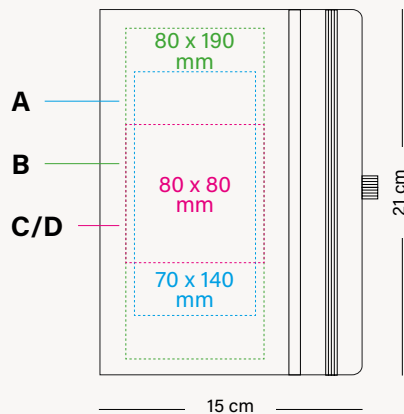

EXTERNAL PACKAGING



25 ± 9,7 KG

FR/ BIC® Partner Hard Cover contient du papier blanc certifié FSC, 80 g/m², sans revêtement artificiel, fabriqué à partir de cellulose d'eucalyptus à fibres courtes et d'une très haute blancheur.

DE/ BIC® Partner Hard Cover enthält FSC-zertifiziertes weißes Papier, 80 g/m², ohne künstliche Beschichtung, hergestellt aus Eukalyptuszellstoff, Kurzfaser, mit hohem Weißgrad.

IT/ BIC® Partner Hard Cover contiene carta bianca certificata FSC, 80 g/m², senza rivestimento artificiale, realizzata in cellulosa di eucalipto, fibra corta, con elevato grado di bianco.

ES/ BIC® Partner Hard Cover contiene papel blanco certificado FSC, de 80 g/m², sin recubrimiento artificial, fabricado con celulosa de eucalipto, de fibra corta y alta blancura.



Pen Holder

FR/ Porte-stylo.
DE/ Stifthalter.
IT/ Portapenna.
ES/ Portabolígrafos.



"If found, please return to" printed on the 1st page

FR/ "En cas de perte, veuillez retourner à" imprimé en anglais sur la 1ère page.
DE/ „Wenn gefunden, bitte zurückgeben an" auf der ersten Seite auf Englisch gedruckt.
IT/ "Se trovato, per favore restituire a" stampato in inglese sulla prima pagina.
ES/ "Si lo encuentra, devuélvalo a" impreso en inglés en la primera página.



Descriptive Leaflet

FR/ Brochure descriptive.
DE/ Beschreibende Broschüre.
IT/ Opuscolo descrittivo.
ES/ Folleto descriptivo.



PRINTING TECHNIQUES



SUSTAINABILITY



FSC AND RECYCLABLE CARDBOARD

BIC GRAPHIC

BIC WRITING INSTRUMENTS

OTHER WRITING INSTRUMENTS

NOTEBOOKS

BIC / DIBEE LIGHTERS AND BIC CASES

BIC PACKAGING

GENERAL INFORMATION

See pages 272-276 for a detailed explanation of the icons.

BIC® PARTNER FLEX COVER



3710

BIC® PARTNER FLEX COVER
3710



Featuring a **soft-touch finish.**

FR/ Finition Soft-Touch
au toucher.

DE/ Ausgestattet mit einer
Soft-Touch-Oberfläche.

IT/ Caratterizzato da una
finitura Soft-Touch al tatto.

ES/ Con un acabado
Soft-Touch al tacto.

DIN A5
72 sheets / 144 pages



02
Black



03
Red



07
Navy Blue



**High-quality, recycled,
FSC-certified paper**

FR/ Papier de haute qualité, recyclé et certifié FSC.
DE/ Hochwertiges, recyceltes, FSC-zertifiziertes Papier.
IT/ Carta di alta qualità, riciclata e certificata FSC.
ES/ Papel de alta calidad, reciclado y certificado por el FSC.



**Elastic
closure**

FR/ Fermeture élastique.
DE/ Elastischer Verschluss.
IT/ Chiusura elastica.
ES/ Cierre elástico.



**Internal
pocket**

FR/ Poche intérieure.
DE/ Innentasche.
IT/ Tasca interna.
ES/ Bolsillo interior.

Pen not included

FR/ Stylo non inclus.

DE/ Stift nicht enthalten.

IT/ Penna non inclusa.

ES/ Bolígrafo no incluido.

BIC® PARTNER FLEX COVER

3710

BIC® PARTNER FLEX COVER

3710

A SP: max. 1 col.

B HS: max. 1 col.

C DB: max. 1 col.

MOQ 25 units

BIC® Partner Flex Cover contain FSC Certified White Paper, 80 g/m², with no artificial coating, made from eucalyptus cellulose, short fibre, with an excellent wrapping and high whiteness.

 LINED PAPER

 Black  Blue  Red

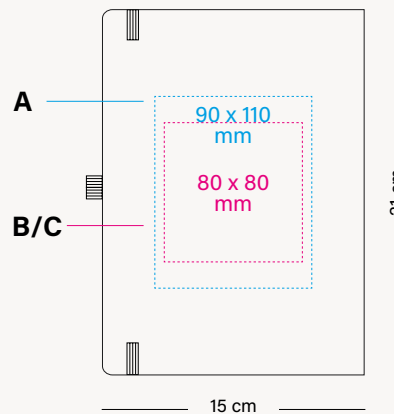
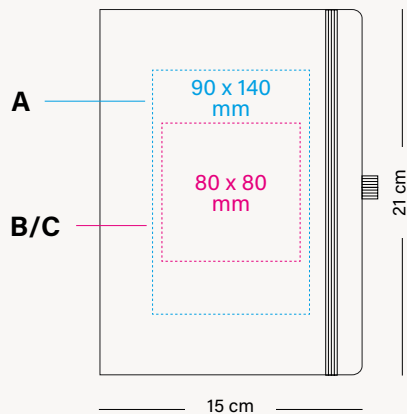

EXTERNAL PACKAGING



FR/ BIC® Partner Flex Cover contient du papier blanc certifié FSC, 80 g/m², sans revêtement artificiel, fabriqué à partir de cellulose d'eucalyptus, fibres courtes, d'une très haute blancheur.

DE/ BIC® Partner Flex Cover enthalten FSC-zertifiziertes weißes Papier, 80 g/m², ohne künstliche Beschichtung, hergestellt aus Eukalyptuszellstoff, Kurzfaser, mit hohem Weißgrad.

IT/ BIC® Partner Flex Cover contengono carta bianca certificata FSC, 80 g/m², senza rivestimento artificiale, realizzata in cellulosa di eucalipto, fibra corta, con elevato grado di bianco.

ES/ BIC® Partner Flex Cover contiene papel blanco certificado FSC, de 80 g/m², sin recubrimiento artificial, fabricado con celulosa de eucalipto, de fibra corta y alta blancura.



Pen Holder

FR/ Porte-stylo.
DE/ Stifthalter.
IT/ Portapenna.
ES/ Portabolígrafos.



If found, please

"If found, please return to" printed on the 1st page

FR/ "En cas de perte, veuillez retourner à" imprimé en anglais sur la 1ère page.
DE/ „Wenn gefunden, bitte zurückgeben an" auf der ersten Seite auf Englisch gedruckt.
IT/ "Se trovato, per favore restituire a" stampato in inglese sulla prima pagina.
ES/ "Si lo encuentra, devuélvalo a" impreso en inglés en la primera página.



Descriptive Leaflet

FR/ Brochure descriptive.
DE/ Beschreibende Broschüre.
IT/ Opuscolo descrittivo.
ES/ Folleto descriptivo.



PRINTING TECHNIQUES



SUSTAINABILITY



FSC AND RECYCLABLE CARDBOARD

BIC GRAPHIC

BIC WRITING INSTRUMENTS

OTHER WRITING INSTRUMENTS

NOTEBOOKS

BIC / DIEEP LIGHTERS AND BIC CASES

BIC PACKAGING

GENERAL INFORMATION

See pages 272-276 for a detailed explanation of the icons.

3711

BIC® PARTNER FRUITCOVER

3711

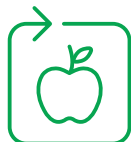

The cover is made from 39% apple waste.

FR/ La couverture est fabriquée à partir de 39% de déchets de pommes.

DE/ Die Hülle besteht zu 39% aus Apfelabfällen.

IT/ La copertina è realizzata per il 39% con scarti di mele.

ES/ La cubierta está fabricada con un 39% de residuos de manzana.

DIN A5

72 sheets / 144 pages



10
Yellow Sand



59
Green Apple



06
Grey Stone



**High-quality, recycled,
FSC-certified paper**

FR/ Papier de haute qualité, recyclé et certifié FSC.
DE/ Hochwertiges, recyceltes, FSC-zertifiziertes Papier.
IT/ Carta di alta qualità, riciclata e certificata FSC.
ES/ Papel de alta calidad, reciclado y certificado por el FSC.



**Elastic
closure**

FR/ Fermeture élastique.
DE/ Elastischer Verschluss.
IT/ Chiusura elastica.
ES/ Cierre elástico.



**Internal
pocket**

FR/ Poche intérieure.
DE/ Innentasche.
IT/ Tasca interna.
ES/ Bolsillo interior.

Pen not included

FR/ Stylo non inclus.

DE/ Stift nicht enthalten.

IT/ Penna non inclusa.

ES/ Bolígrafo no incluido.

BIC® PARTNER FRUITCOVER

3711

BIC® PARTNER FRUITCOVER

3711

A SP: max. 1 col.

B HS: max. 1 col.

C DB: max. 1 col.

MOQ 25 units

BIC® Partner FruitCover contains Recycled FSC Certified Ivory Paper, 80 g/m².



LINED PAPER



Green Apple



Grey Stone



Yellow Sand

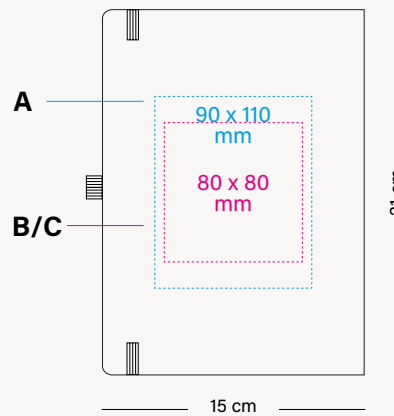
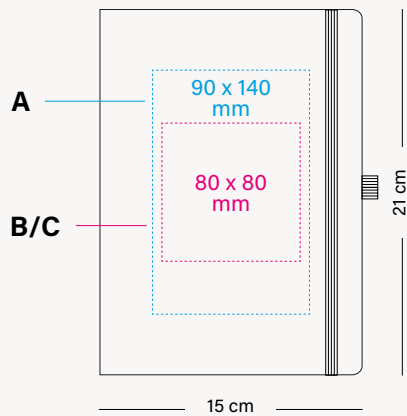

EXTERNAL PACKAGING



25 ± 9,7 KG

FR/ BIC® Partner FruitCover contient du papier recyclé de couleur ivoire, avec certification FSC, 80 g/m².

DE/ BIC® Partner FruitCover enthält recyceltes Papier in Elfenbeinfarbe, mit FSC-Zertifizierung, 80 g/m².

IT/ BIC® Partner FruitCover contiene carta riciclata di colore avorio, con certificazione FSC, 80 g/m².

ES/ BIC® Partner FruitCover contiene papel de color marfil reciclado, con certificación FSC, 80 g/m².



Pen Holder

FR/ Porte-stylo.
DE/ Stifthalter.
IT/ Portapenna.
ES/ Portabolígrafos.



If found, please

"If found, please return to" printed on the 1st page

FR/ "En cas de perte, veuillez retourner à" imprimé en anglais sur la 1ère page.
DE/ „Wenn gefunden, bitte zurückgeben an" auf der ersten Seite auf Englisch gedruckt.
IT/ "Se trovato, per favore restituire a" stampato in inglese sulla prima pagina.
ES/ "Si lo encuentra, devuélvalo a" impreso en inglés en la primera página.



Descriptive Leaflet

FR/ Brochure descriptive.
DE/ Beschreibende Broschüre.
IT/ Opuscolo descrittivo.
ES/ Folleto descriptivo.



PRINTED IN BIC FACTORIES



MADE IN ITALY



PRINTING TECHNIQUES



SCREEN PRINTING



HOT STAMPING



DEBOSSING

SUSTAINABILITY



FSC AND RECYCLABLE CARDBOARD

BIC GRAPHIC

BIC WRITING INSTRUMENTS

OTHER WRITING INSTRUMENTS

NOTEBOOKS

BIC / DIEEP LIGHTERS AND BIC CASES

BIC PACKAGING

GENERAL INFORMATION

See pages 272-276 for a detailed explanation of the icons.

BIC® PARTNER NOTEBOOKS

Personalise your perfect BIC® Partner Notebook
with our NEW TAILORMADE SERVICE



**Choose your colour,
even Pantone!**

Available with:

BIC® Partner Hard Cover

**Digital Art Paper, cover fully printed
on front and back, on 100% of surface.**

Available with:

BIC® Partner Hard Cover

**Personalise
internal pages**

Available with:

BIC® Partner Hard Cover

BIC® Partner Flex Cover

BIC® Partner Fruitcover



Made
in Italy

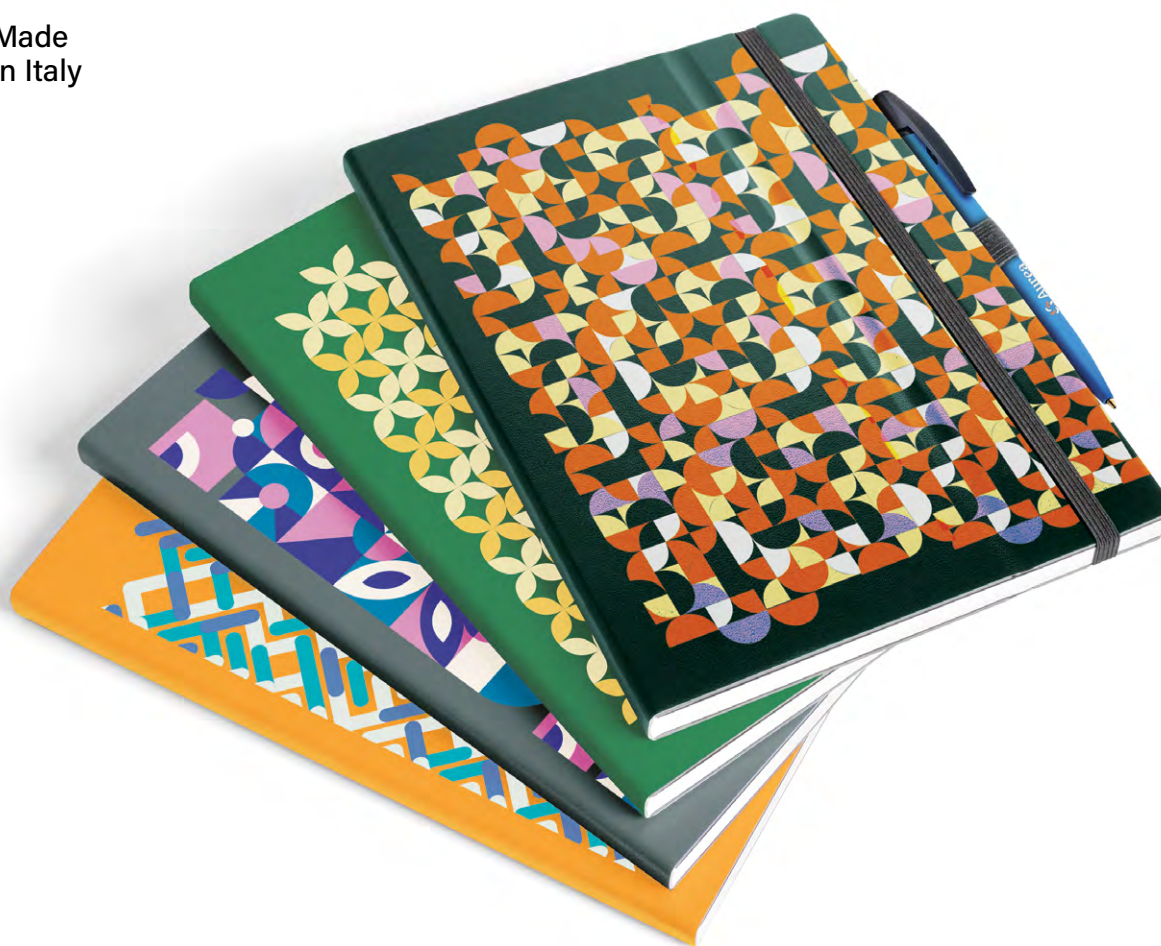

Contact your sales representative for more information

FR/

**Personnalisez votre carnet BIC® Partner avec
notre NOUVEAU SERVICE SUR MESURE**

- Choisissez votre couleur —même le Pantone !
- Digital Art Paper, couverture entièrement imprimée à l'avant et à l'arrière, sur 100 % de la surface.
- Personnalisez les pages intérieures.

** Contactez votre représentant commercial pour plus d'informations.*

DE/

**Personalisieren Sie Ihr perfektes BIC® Partner Notebook
mit unserem NEUEN MASSGESCHNEIDERTEN SERVICE**

- Wählen Sie Ihre Farbe - sogar Pantone!
- Digital Art Paper, Umschlag vollständig vorne und hinten bedruckt, auf 100 % der Oberfläche.
- Individualisieren Sie die Innenseiten.

** Wenden Sie sich an Ihren Vertriebsmitarbeiter, um weitere Informationen zu erhalten.*



BIC GRAPHIC

BIC® WRITING INSTRUMENTS

OTHER WRITING INSTRUMENTS

NOTEBOOKS

BIC® / DIEEP® LIGHTERS AND BIC® CASES

BIC® PACKAGING

GENERAL INFORMATION

Contact your sales representative for more information

IT/
Personalizza il tuo taccuino BIC® Partner perfetto con il nostro NUOVO SERVIZIO SU MISURA

- Scegli colore—anche Pantone!
- Digital Art Paper, copertina completamente stampata davanti e dietro sul 100% della superficie.
- Personalizza le pagine interne.

*Contatta il tuo rappresentante commerciale per maggiori informazioni.

ES/
Personaliza tu libreta BIC® Partner perfecta con nuestro NUEVO SERVICIO A MEDIDA

- Elige tu color—¡Incluso Pantone!
- Digital Art Paper, cubierta completamente impresa por delante y por detrás, en el 100% de la superficie.
- Personaliza las páginas interiores.

*Contacta a tu representante de ventas para más información.

**BIC® / DJEEP®
LIGHTERS AND
BIC® CASES**

04

BIC® LIGHTERS

The iconic, well-loved and time-honoured shapes of BIC® lighters remain on trend!

Five different models and a wide range of colour combinations.

FR/

Le célèbre briquet BIC®, une icône indémodable, avec un design toujours tendance !

Cinq modèles différents et une large gamme de combinaisons de couleurs.

DE/

Das legendäre, beliebte und bewährte Design des BIC®-Feuerzeugs liegt weiter im Trend!

Fünf verschiedene Modelle und eine große Auswahl an Farbkombinationen.

IT/

L'iconico, amato e intramontabile design dell'accendino BIC® resta di tendenza!

Cinque modelli diversi e un'ampia gamma di combinazioni di colori.

ES/

¡El diseño icónico, querido y atemporal del encendedor BIC® sigue siendo tendencia!

Cinco modelos diferentes y una amplia gama de combinaciones de colores.

Light up



BIC® LIGHTERS FAMILY

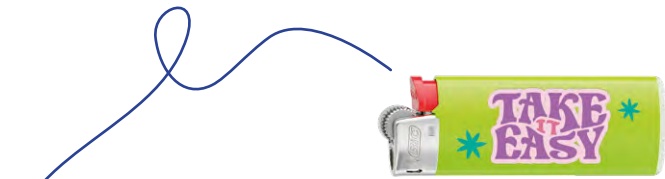

2360
BIC® J25 Lighter
Screen Printing



2360
BIC® J25 Lighter
Digital Printing



2340
BIC® J23 Lighter
Screen Printing



2340
BIC® J23 Lighter
Digital Printing



2320
BIC® J26 Lighter
Screen Printing



2320
BIC® J26 Lighter
Digital Printing



2452
BIC® J38 Lighter
Screen Printing



2452
BIC® J38 Lighter
Digital Printing



2450
BIC® EZ Reach™ Lighter
Screen Printing



2450
BIC® EZ Reach™ Lighter
Digital Printing

BIC
GRAPHIC

BIC®
WRITING INSTRUMENTS

OTHER WRITING
INSTRUMENTS

NOTEBOOKS

BIC® / DJEEP® LIGHTERS
AND BIC® CASES

BIC®
PACKAGING

GENERAL
INFORMATION

BIC® lighters. Our quality, your safety.

All BIC® lighters meet or exceed international standards and regulations requirements (ISO 9994, EN 13869, ASTM F400, US CPSC).
Don't risk it, buy a BIC® lighter!



BIC® is number one worldwide for branded lighters.*



100 % of BIC® Lighters sold by BIC Graphic Europe are manufactured by BIC in Europe. All BIC® Lighters are made in BIC factories. This is the starting block of the BIC® lighter safety guarantee.

50 YEARS

BIC has acquired 50 years of incredible manufacturing expertise to guarantee the safety and quality of its products.

50 CHECKS

Before leaving the factory, every BIC® Lighter undergoes more than 50 automatic quality and security checks.

FR /

BIC® est le numéro un mondial des briquets de marque.

100 % des briquets BIC® vendus par BIC Graphic Europe sont fabriqués par BIC en Europe.

BIC a acquis 50 ans d'une incroyable expertise de fabrication afin de garantir la sécurité et la qualité de ses produits.

Avant de quitter l'usine, chaque briquet BIC® subit plus de 50 contrôles automatiques de qualité et de sécurité.

DE /

BIC® ist weltweit die Nummer eins bei Markenfeuerzeugen.

100 % der von BIC Graphic Europe verkauften BIC®-Feuerzeuge werden von BIC in Europa hergestellt.

BIC hat in 50 Jahren eine unglaubliche Fertigungskompetenz erworben und kann somit die Sicherheit und Qualität seiner Produkte gewährleisten.

Jedes BIC® Feuerzeug durchläuft vor Verlassen des Werks über 50 automatische Qualitäts- und Sicherheitskontrollen.

IT /

BIC® è il numero uno al mondo fra gli accendini di marca.

Il 100% degli accendini BIC® venduti da BIC Graphic Europe è prodotto da BIC in Europa.

BIC® ha acquisito 50 anni di incredibile esperienza di produzione per garantire la sicurezza e la qualità dei propri prodotti.

Prima di lasciare la fabbrica, ogni accendino BIC® viene sottoposto a oltre 50 controlli automatici di qualità e sicurezza.

ES /

BIC® es el número uno mundial en encendedores de marca.

El 100 % de los encendedores BIC® vendidos por BIC Graphic Europe son fabricados por BIC en Europa.

Durante 50 años BIC ha adquirido increíbles conocimientos de fabricación para garantizar la seguridad y calidad de sus productos.

Antes de salir de fábrica, cada encendedor BIC® se somete a más de 50 controles automáticos de calidad y seguridad.

*BIC® lighter market share in 2022, excluding the Asian market.



With more than 50 years of experience as a guarantee!



Screen printing

Perfect technique for creating high-quality prints and exact colour matches.



Brilliant

Choose the brilliant finish for a dazzling final effect.



Matt

Use the matt finish to add a touch of elegance to your design.



Metallic

Create great effects! Metallic effects in text, images and backgrounds.

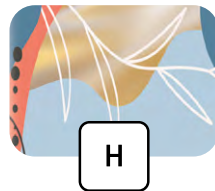

Holographic

Stand out from the crowd! Play with gold or silver reflections in your design.



Puffy

Highlighted personalisation that gives a relief effect to your logo.



Puffy Glitter

Embellish your designs with the shimmering effect of glitter. See and feel its coloured glitter texture.



UV

Highlight your brand with a high-gloss finish! Combine a matt and gloss finish to highlight contrasts.



BritePix™ Digital

The solution for full-colour communication. Now on coloured barrels!



BIC® Lighters finishes

Perfect for your pocket!

2360 / 2364

BIC® J25 LIGHTER
2360
2364 All Black



Iconic BIC® Boy and BIC® logo engraved!



01 57 57 8G 03 11 59 24



25 25 6W 02 02 02 02

1:1 scale

FR /
**Parfait pour
votre poche !**

DE /
**Passt perfekt in
die Hosentasche!**

IT /
**Perfetto per
le tue tasche!**

ES /
**¡Perfecto para
tu bolsillo!**

BIC® J25 LIGHTER

2360/2364

BIC® J25 LIGHTER

2360/2364

A/C SP: max. 4 col.

MOQ 300 units

2360/2364

BIC® J25 LIGHTER BRITEPIX™

2360 / 2364

A/C BP: full-colour

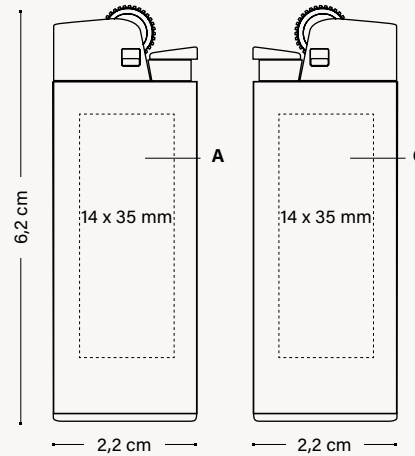
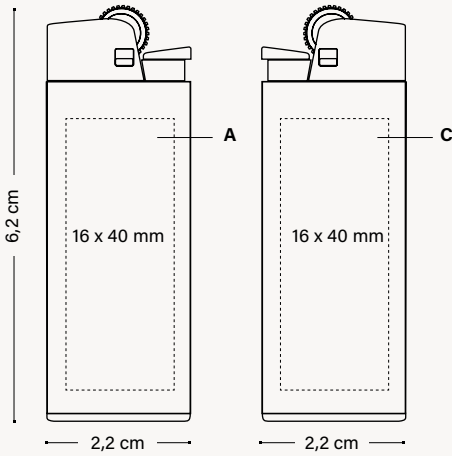

PACKAGING



100% recycled!

STANDARD PACKAGING:
IN TRAY OF 50 UNITS

EXTERNAL PACKAGING



600 ± 76 KG



FSC AND
RECYCLABLE
CARDBOARD

OPTIONAL INNER PACKAGING

0087

COUNT BOX 10 UNITS CASES



0088

COUNT BOX 10 UNITS
CASES CHILD RESISTANT



0086

COUNT BOX 10 UNITS
J25 CHILD RESISTANT



PRINTING
TECHNIQUES



SUSTAINABILITY



100% ELECTRICITY
COMING FROM
RENEWABLE SOURCES



Check out
the video

BIC
GRAPHIC

BIC®
WRITING INSTRUMENTS

OTHER WRITING
INSTRUMENTS

NOTEBOOKS

BIC® / DJEEP® LIGHTERS
AND BIC® CASES

BIC®
PACKAGING

GENERAL
INFORMATION

See pages 272-276 for a detailed explanation of the icons.

DIGITAL FINISHES



BR BRILLIANT



MT MATT

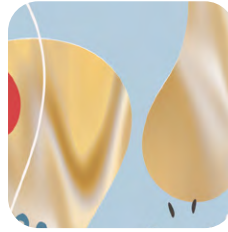

H HOLOGRAPHIC SILVER GOLD



P PUFFY



M METALLIC



UV UV



PG PUFFY GLITTER

2360

BIC® J25 LIGHTER
2360



MT MATT

P PUFFY

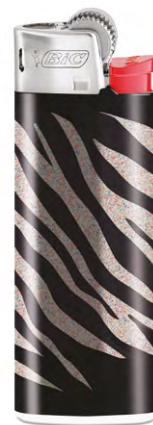

PG PUFFY GLITTER



MT MATT

M METALLIC

1:1 scale

360°
Printing

BIC® J25 LIGHTER

2360

BIC® J25 LIGHTER

2360

A DG: full-colour

MOQ 600 units

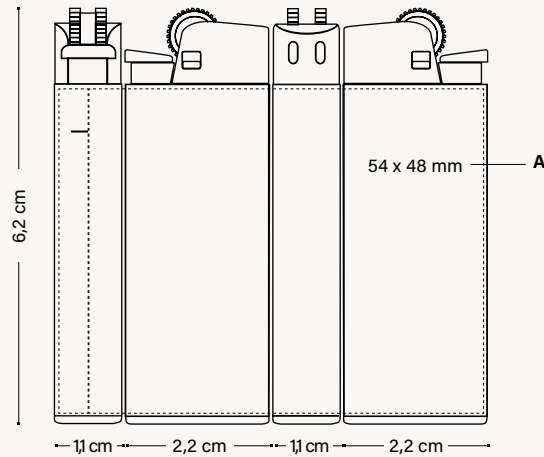

PRINTING TECHNIQUES



SUSTAINABILITY



PACKAGING



100% recycled!

STANDARD PACKAGING:
IN TRAY OF 50 UNITS

EXTERNAL PACKAGING



600 ± 76 KG



FSC AND RECYCLABLE CARDBOARD

OPTIONAL INNER PACKAGING

0087

COUNT BOX 10 UNITS CASES



0088

COUNT BOX 10 UNITS CASES CHILD RESISTANT



0086

COUNT BOX 10 UNITS J25 CHILD RESISTANT



Check out the video

See pages 272-276 for a detailed explanation of the icons.

BIC® J23 LIGHTER



Iconic BIC® Boy
and BIC® logo
engraved!

2340

BIC® J23 LIGHTER
2340



57



12



03



10

*Slim and fits
everywhere!*



1:1 scale



05



04



25



02

BIC® J23 LIGHTER

2340

BIC® J23 LIGHTER

2340

A/C SP: max. 4 col.

MOQ 300 units

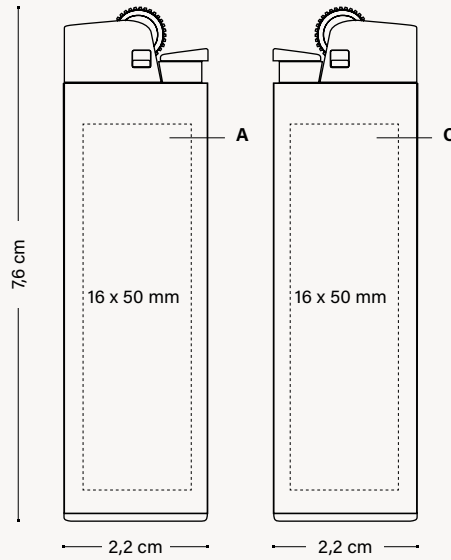

PACKAGING



100% recycled!

STANDARD PACKAGING:
IN TRAY OF 50 UNITS

EXTERNAL PACKAGING



600 ± 9,5 KG



FSC AND
RECYCLABLE
CARDBOARD

OPTIONAL INNER PACKAGING

0087

COUNT BOX 10 UNITS CASES



0088

COUNT BOX 10 UNITS
CASES CHILD RESISTANT



PRINTING
TECHNIQUES



SUSTAINABILITY



Check out
the video

See pages 272-276 for a detailed explanation of the icons.

DIGITAL FINISHES



BR BRILLIANT



MT MATT

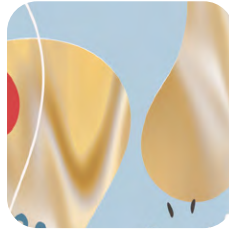

H HOLOGRAPHIC SILVER GOLD



P PUFFY



M METALLIC



UV UV



PG PUFFY GLITTER

2340

BIC® J23 LIGHTER
2340



MT MATT

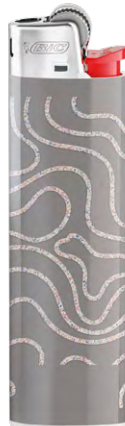

PG PUFFY GLITTER



BR BRILLIANT

H HOLOGRAPHIC GOLD

360°
Printing

1:1 scale

BIC® J23 LIGHTER

2340

BIC® J23 LIGHTER

2340

A DG: full-colour

MOQ 600 units

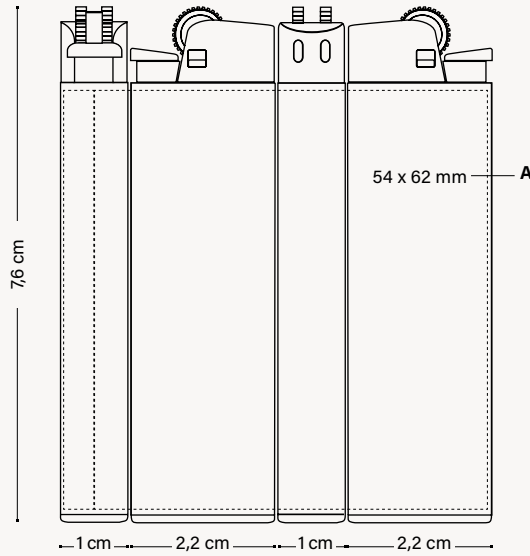

PRINTING TECHNIQUES



PACKAGING



100% recycled!

STANDARD PACKAGING:
IN TRAY OF 50 UNITS

EXTERNAL PACKAGING



600 ± 9,5 KG



FSC AND RECYCLABLE CARDBOARD

OPTIONAL INNER PACKAGING

0087

COUNT BOX 10 UNITS CASES



0088

COUNT BOX 10 UNITS CASES CHILD RESISTANT



Check out the video

See pages 272-276 for a detailed explanation of the icons.

The flame that lasts.



Iconic BIC® Boy and BIC® logo engraved!

2320

BIC® J26 LIGHTER
2320



01



57



8G



10B



6W

Extra long-lasting: up to 3.000 lights!



1:1 scale



59



24



25



02



03

FR /
**La flamme
qui dure.**

DE /
**Die Flamme,
die anhält.**

IT /
**La fiamma
che dura.**

ES /
**La llama
que dura.**

BIC® J26 LIGHTER

2320

BIC® J26 LIGHTER

2320

A/C SP: max. 4 col.

MOQ 300 units

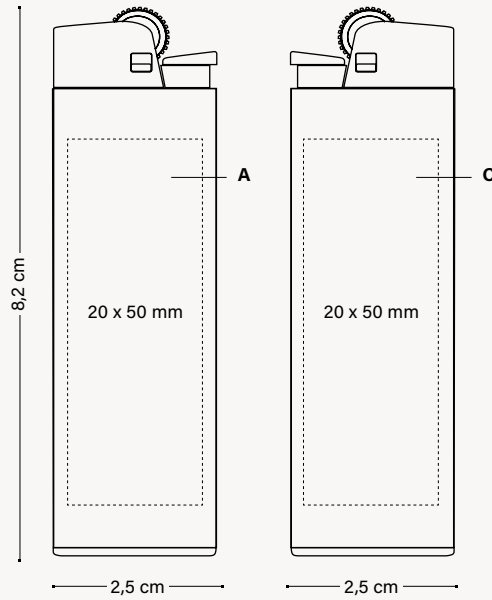

PACKAGING



100% recycled!

STANDARD PACKAGING:
IN TRAY OF 50 UNITS

EXTERNAL PACKAGING



600 ± 15,1 KG



FSC AND
RECYCLABLE
CARDBOARD

OPTIONAL INNER PACKAGING

0087

COUNT BOX 10 UNITS CASES



0088

COUNT BOX 10 UNITS
CASES CHILD RESISTANT



Check out
the video

See pages 272-276 for a detailed explanation of the icons.

DIGITAL FINISHES



BR BRILLIANT



MT MATT

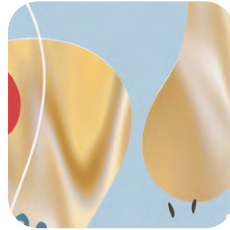

H HOLOGRAPHIC SILVER GOLD



P PUFFY



M METALLIC



UV UV



PG PUFFY GLITTER

2320

BIC® J26 LIGHTER
2320



MT MATT



BR BRILLIANT



MT MATT

360°
Printing

1:1 scale

BIC® J26 LIGHTER

2320

BIC® J26 LIGHTER

2320

A DG: full-colour

MOQ 600 units

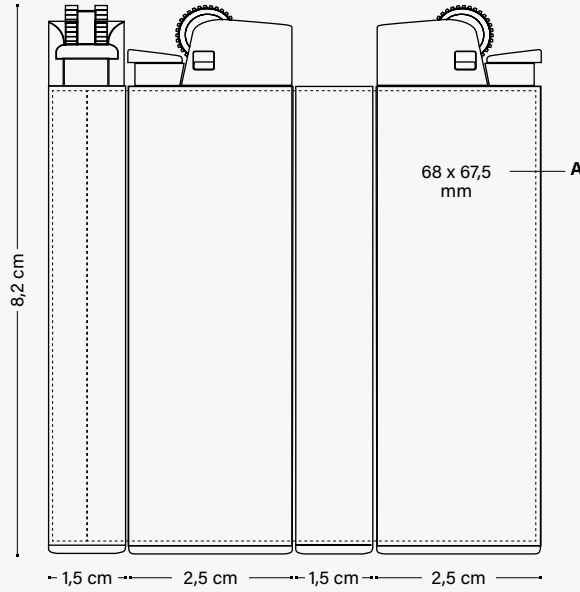

PACKAGING



100% recycled!

STANDARD PACKAGING:
IN TRAY OF 50 UNITS

EXTERNAL PACKAGING



600 ± 15,1 KG



FSC AND RECYCLABLE CARDBOARD

OPTIONAL INNER PACKAGING

0087

COUNT BOX 10 UNITS CASES



0088

COUNT BOX 10 UNITS CASES CHILD RESISTANT



Check out the video

See pages 272-276 for a detailed explanation of the icons.

BIC® J38 LIGHTER

2452



Iconic BIC® Boy and BIC® logo engraved!

BIC® J38 LIGHTER
2452



57



25



02



03



Elegant and comfortable lighting!

1:1 scale

BIC® J38 LIGHTER

2452

BIC® J38 LIGHTER

2452

A/C SP: max. 4 col.

MOQ 300 units

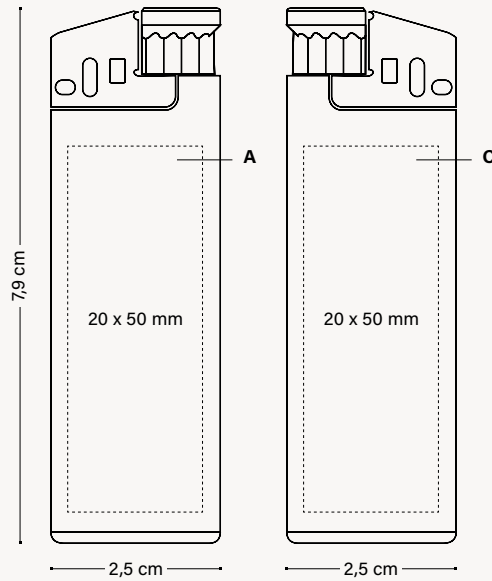

PACKAGING



100% recycled!

STANDARD PACKAGING:
IN TRAY OF 50 UNITS

EXTERNAL PACKAGING



600 ± 13,2 KG



FSC AND
RECYCLABLE
CARDBOARD

OPTIONAL INNER PACKAGING

0087

COUNT BOX 10 UNITS CASES



0088

COUNT BOX 10 UNITS
CASES CHILD RESISTANT



PRINTING
TECHNIQUES



SUSTAINABILITY



Check out
the video

See pages 272-276 for a detailed explanation of the icons.

BIC® J38 LIGHTER

FINISHES



BR BRILLIANT



MT MATT

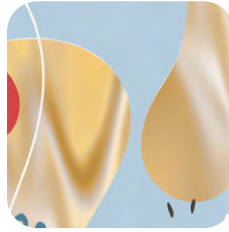

H HOLOGRAPHIC
SILVER
GOLD



P PUFFY



M METALLIC



UV UV



PG PUFFY GLITTER

2452

BIC® J38 LIGHTER
2452



57

BR BRILLIANT



57

MT MATT



57

MT MATT

H HOLOGRAPHIC
GOLD

360°
Printing

1:1 scale

BIC® J38 LIGHTER

2452

BIC® J38 LIGHTER

2452

A DG: full-colour

MOQ 600 units

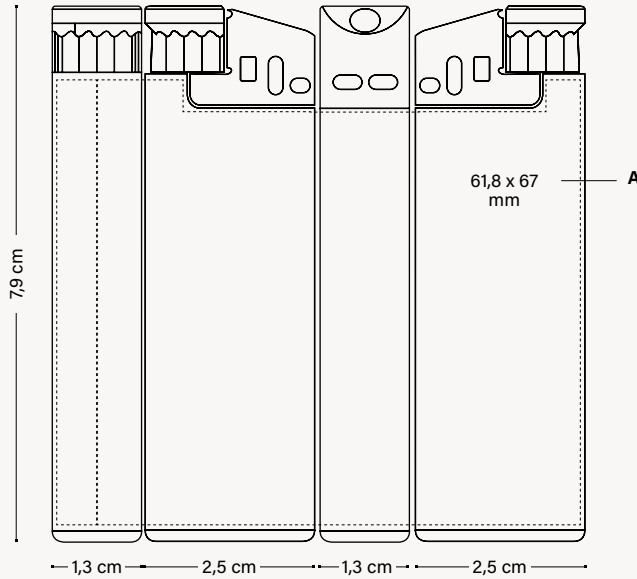

PRINTING TECHNIQUES



SUSTAINABILITY



PACKAGING



100% recycled!

STANDARD PACKAGING:
IN TRAY OF 50 UNITS

EXTERNAL PACKAGING



600 ± 13,2 KG



FSC AND RECYCLABLE CARDBOARD

OPTIONAL INNER PACKAGING

0087

COUNT BOX 10 UNITS CASES



0088

COUNT BOX 10 UNITS CASES CHILD RESISTANT



Check out the video

See pages 272-276 for a detailed explanation of the icons.

SAFETY FLAME

Helps keep fingers away from the flame.



Long lasting with up to 900 flames

Stable flame

thanks to the pure isobutane gas



Convenient format

Easily fits in the pocket



Made in Spain



Convenient for different flame occasions



Safe & Reliable



Keeps fingers away from the flame thanks to its 3.5 cm wand

High force ignition system



Made with 100% electricity coming from renewable sources

High resistance

Made of high mechanical resistance resin Delrin®

FR /
FLAMME SÛRE.
Les doigts restent éloignés de la flamme.

DE /
SICHERHEITS-FLAMME.
Hilft die Finger von der Flamme fernzuhalten.

IT /
FIAMMA SICURA.
Aiuta a tenere le dita lontane dalla fiamma.

ES /
LLAMA SEGURA.
Ayuda a mantener los dedos alejados de la llama.

BIC® EZ REACH™ LIGHTER



2450

BIC® EZ REACH™ LIGHTER
2450

A SP: max. 1 col.
B BP: full-colour

MOQ 300 units

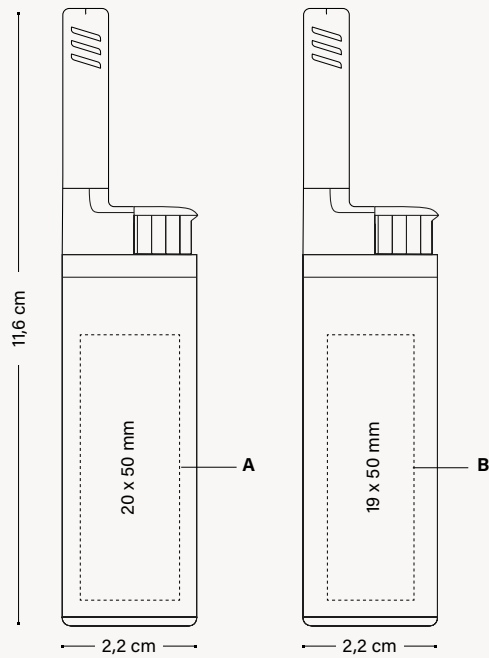

PACKAGING



STANDARD PACKAGING:
IN TRAY OF 50 UNITS

EXTERNAL PACKAGING



150 ± 3.8 KG



FSC AND
RECYCLABLE
CARDBOARD



PRINTING TECHNIQUES



SUSTAINABILITY



100% ELECTRICITY
COMING FROM
RENEWABLE SOURCES

BIC
GRAPHIC

BIC®
WRITING INSTRUMENTS

OTHER WRITING
INSTRUMENTS

NOTEBOOKS

BIC® / DJEEP® LIGHTERS
AND BIC® CASES

BIC®
PACKAGING

GENERAL
INFORMATION

See pages 272-276 for a detailed explanation of the icons.

BIC® CASES & OTHER BIC® PRODUCTS

Style your lighter with unique, customizable cases! Protect it, personalize it, and stand out.

FR/

Personnalisez votre briquet avec des étuis uniques et personnalisables !

Protégez-le, personnalisez-le et démarquez-vous.

DE/

Gestalten Sie Ihr Feuerzeug mit einzigartigen, individuell anpassbaren Hüllen! Schützen Sie es, personalisieren Sie es und heben Sie sich von der Masse ab.

IT/

Personalizza il tuo accendino con custodie uniche e personalizzabili!

Proteggilo, personalizzalo e distinguiti dalla massa.

ES/

¡Dale estilo a tu encendedor con fundas únicas y personalizables!

Protégelo, personalízalo y destaca entre los demás.

Make it yours



2386
BIC® Styl'it Luxury Case



2156
BIC® Aluminium Flat Case



2398
BIC® Clip Case



2395
BIC® 3D Case



3850
BIC® Pocket Ashtray



3851
BIC® Pocket Ashtray Kraft

BIC
GRAPHIC

BIC®
WRITING INSTRUMENTS

OTHER WRITING
INSTRUMENTS

NOTEBOOKS

BIC® / DJEEP® LIGHTERS
AND BIC® CASES

BIC®
PACKAGING

GENERAL
INFORMATION

BIC® STYL'IT LUXURY CASE

2386

BIC® STYL'IT LUXURY CASE
2386



All cases are delivered with a white BIC® 125 lighter!



59

01

1:1 scale

BIC® STYL'IT LUXURY CASE

2386

BIC® STYL'IT LUXURY CASE
2386

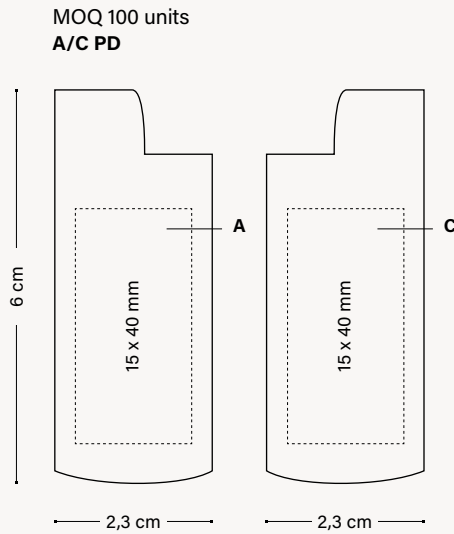
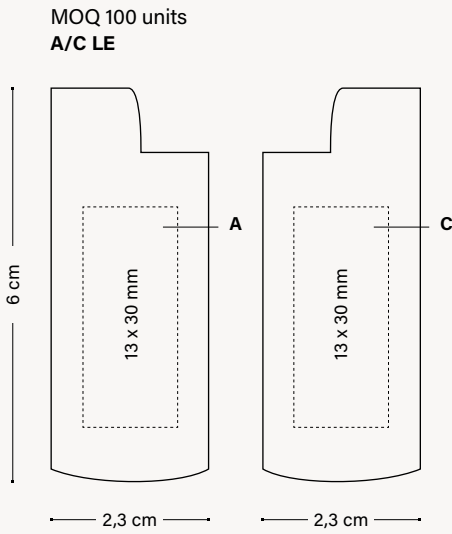

PACKAGING



STANDARD PACKAGING:
BOX FOR 10 UNITS

EXTERNAL PACKAGING



300 ± 6,1 KG



FSC AND
RECYCLABLE
CARDBOARD

OPTIONAL INNER PACKAGING

4551

BOX OF 50 UNITS METAL STYL'IT CASE



PRINTING
TECHNIQUES



SUSTAINABILITY



BIC
GRAPHIC

BIC®
WRITING INSTRUMENTS

OTHER WRITING
INSTRUMENTS

NOTEBOOKS

BIC® / DJEEP® LIGHTERS
AND BIC® CASES

BIC®
PACKAGING

GENERAL
INFORMATION

See pages 272-276 for a detailed explanation of the icons.

BIC® ALUMINIUM FLAT CASE

2156

BIC® ALUMINIUM FLAT CASE
2156

3 customisable sides!



All cases are delivered with a white BIC® J25 lighter!



1:1 scale

47

2156

BIC® ALUMINIUM FLAT CASE
2156

MOQ 100 units
A/C PD: max. 1 col.

MOQ 100 units
A/B/C BP: full-colour

MOQ 100 units
A/B/C LE

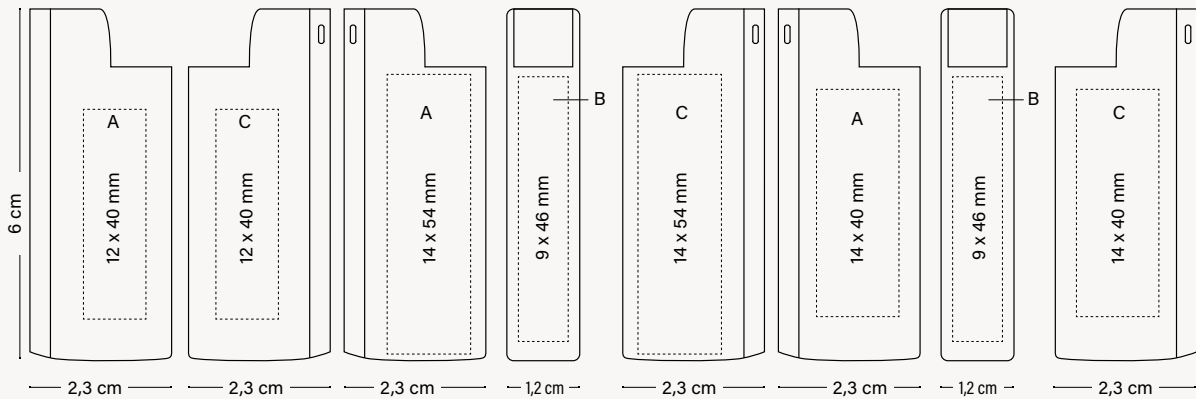

PACKAGING



STANDARD PACKAGING:
BOX FOR 50 UNITS

EXTERNAL PACKAGING



300 ± 7,5 KG



FSC AND
RECYCLABLE
CARDBOARD



PRINTED IN
BIC FACTORIES



REGULATORY
COMPLIANCE

PRINTING TECHNIQUES

PD PAD PRINTING

BP BRITEPIX™
BRITEPIX™ PERSONALISATION

LE LASER

SUSTAINABILITY



BIC® CLIP CASE

2398

BIC® CLIP CASE
2398



All cases are delivered with a white BIC® J25 lighter!



2398

BIC® CLIP CASE
2398

MOQ 100 units
A/C PD: max. 1 col.

MOQ 100 units
A/C BP: full-colour
BP Texture: full-colour

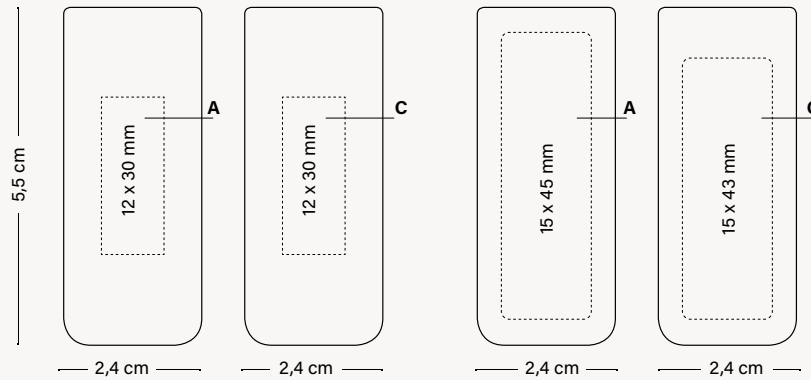

PACKAGING



STANDARD PACKAGING:
BOX FOR 50 UNITS

EXTERNAL PACKAGING



300 ± 7,5 KG



FSC AND RECYCLABLE CARDBOARD



PRINTED IN BIC FACTORIES



REGULATORY COMPLIANCE



PRINTING TECHNIQUES

PD PAD PRINTING

BP BRIPEPIX™
BRIPEPIX™ PERSONALISATION

SUSTAINABILITY



See pages 272-276 for a detailed explanation of the icons.

2395

BIC® 3D CASE

2395



All cases are delivered with a white BIC® J25 lighter!



Convert your logo into a 3D shape!

1:1 scale



BIC® 3D CASE

2395

BIC® 3D CASE

2395

A/C 3D: max. 6 col.

MOQ 1.200 units

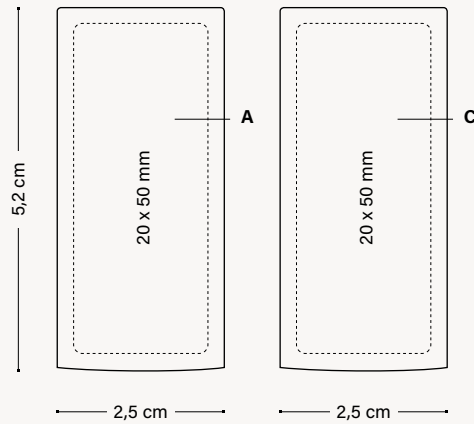

PACKAGING



STANDARD PACKAGING:
BOX FOR 50 UNITS

EXTERNAL PACKAGING



300 ± 7,5 KG



FSC AND
RECYCLABLE
CARDBOARD



REGULATORY
COMPLIANCE



PRINTING
TECHNIQUES



EMBOSSING

BIC
GRAPHIC

BIC®
WRITING INSTRUMENTS

OTHER WRITING
INSTRUMENTS

NOTEBOOKS

BIC® / DJEEP® LIGHTERS
AND BIC® CASES

BIC®
PACKAGING

GENERAL
INFORMATION

See pages 272-276 for a detailed explanation of the icons.

BIC® POCKET ASHTRAY

3850

BIC® POCKET ASHTRAY
3850

6 different
flap shapes
available!

Reusable and
hermetic!



1:1 scale

3850

BIC® POCKET ASHTRAY
3850

A SP: max. 5 col. (max. 2 col.
for orders under 20.000 pcs.)

MOQ 5.000 units

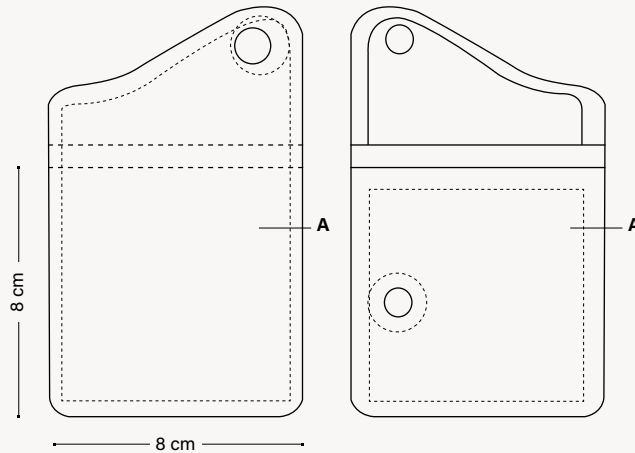

PACKAGING



BOX FOR 10 UNITS EACH
BIC® POCKET ASHTRAY
COMES IN AN INDIVIDUAL
CELLOPHANE PACKAGING

EXTERNAL PACKAGING



500 ± 5,5 KG



REGULATORY
COMPLIANCE

PRINTING TECHNIQUES

SP SCREEN PRINTING

Please contact your Customer Service Representative for further details.

BIC® POCKET ASHTRAY

3851

BIC® POCKET ASHTRAY
3851 Kraft



1:1 scale

6F

3851

BIC® POCKET ASHTRAY KRAFT

3851 Kraft

A SP: max. 2 col.

MOQ 10.000 units

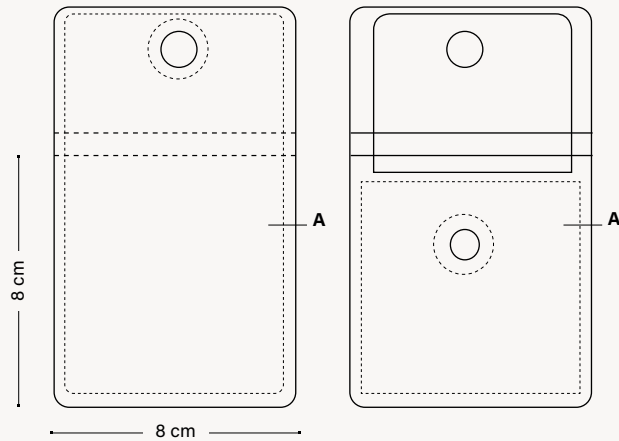

PACKAGING



BOX FOR 10 UNITS EACH
BIC® POCKET ASHTRAY
COMES IN AN INDIVIDUAL
CELLOPHANE PACKAGING.

EXTERNAL PACKAGING



500 ± 5,5 KG



REGULATORY
COMPLIANCE

PRINTING TECHNIQUES



SCREEN PRINTING

See pages 272-276 for a detailed explanation of the icons.

DJEEP® LIGHTERS

Long-lasting and designed with style. DJEEP® is crafted to function perfectly. Each lighter is fully tested to ensure it meets our top-quality criteria.

FR/

Durable et conçu avec style. Le briquet DJEEP® est créé pour fonctionner parfaitement. Chaque briquet est entièrement testé pour s'assurer qu'il répond à nos critères de qualité les plus stricts.

DE/

Langlebig und stilvoll gestaltet. DJEEP® ist so konzipiert, dass es perfekt funktioniert. Jedes Feuerzeug wird eingehend getestet, um sicherzustellen, dass es unsere hohen Qualitätskriterien erfüllt.

IT/

Di lunga durata e progettato con stile. Ogni accendino è completamente testato per garantire la soddisfazione dei nostri criteri di massima qualità.

ES/

Duradero y diseñado con estilo. DJEEP® está diseñado para funcionar a la perfección. Cada encendedor se somete a pruebas exhaustivas para garantizar que cumple nuestros criterios de máxima calidad.



08D1
DJEEP® D1 Lighter



08D1
DJEEP® D1 Lighter



08D1
DJEEP® D1 Lighter



08D1
DJEEP® D1 Lighter

Ignite your spark

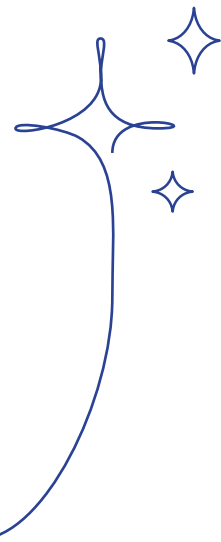



**Ignite your
mark.**

We are
premium

We are
singular



We are
engaged

We are
creative

DJEEP® D1 LIGHTER

Long-lasting and designed with style. DJEEP® is crafted to function perfectly. Each lighter is fully tested to ensure it meets our top-quality criteria.



STABLE FLAME

thanks to pure isobutane fuel



A LONG-LASTING LIGHTER

thanks to triple-tank technology



HIGH RESISTANCE

reservoir made of high mechanical resistance resin



LARGER PUSHER

for a better comfort of use



HIGH-END EFFECTS

QUALITY MADE
compliant with international safety standards. Made in France



UNIQUE RECTANGULAR SHAPE

to offer comfort in hand and a large surface of expression

CHILD-RESISTANT SAFETY GUARD

compliant with EN 13869 Standard



FR /
Flamme stable.
Grand poussoir.
Un briquet conçu pour durer.
Effets haut de gamme.
Très résistant.
Forme rectangulaire unique.
Sécurité enfants.

DE /
Stabile Flamme.
Großer Drücker.
Ein langlebiges Feuerzeug.
Hochwertige Effekte.
Hohe Widerstandsfähigkeit.
Einzigartige rechteckige Form.
Kindersicherung.

IT /
Fiamma stabile.
Pulsante grande.
Un accendino di lunga durata.
Effetti di alta gamma.
Alta resistenza.
Forma rettangolare unica.
Dispositivo di sicurezza
a prova di bambino.

ES /
Llama estable.
Pulsador grande.
Un encendedor de
larga duración.
Efectos de gama alta.
Alta resistencia.
Forma rectangular única.
Protección de seguridad
a prueba de niños.

360° Digital Decoration

DJEEP® offers a wide variety of digital printing effects; select from touch & feel, glossy & matt mix, etched, Holographik®, ... to elevate each lighter.



01. Base. Select between:
 WM WHITE MEDIUM M METALLIC SILVER H HOLOGRAPHIC

03. Finish. Select between:
 G GLOSSY MT MATT ST DJEEP SOFT TOUCH®

02. Printing: We select the best option for you (digital, offset, flexo, silk screen ...) depending on quantity and design options.

04. Decoration options. Select up to 2 different decoration options between: GRANITE, FABRIC, DJEEP® SOFT TOUCH®, RESIN CHIP, TOUCH&FEEL, GLOSSY & MATT MIX, BLACK LIGHT, HAMMERED METAL, GLITTERING, FRAGRANT INK, GLOW IN THE DARK, ETCHED, QR CODE, HOLOGRAPHIK®, PEARLESCENT.

DECORATION POSSIBILITIES



ST

DJEEP® SOFT TOUCH®

Provide a unique smooth sensation! Deep tones and a soft surface for an exclusive experience.



GT

GLITTERING

Add a sparkling effect to your design! Make your colours vibrant!



HM

HAMMERED METAL

A metallic background with a puffy effect pattern. A premium look and feel that stands out!

DJEEP® LIGHTERS



TF

TOUCH & FEEL

Give an embossed effect to your design!



ET

ETCHED

Gives an etched or engraved effect to the lighter!
Create patterns and convert your idea into an elegant design.



GM

GLOSSY & MATT MIX

Choose this finish to create distinctions between matt or DJEEP® Soft Touch® and the UV varnish that produces vivid colours.



FI

FRAGRANT INK

Rub the label and enjoy the fragrance!
Available fragrances: Mint, Red Fruits, Mojito, Lime and Pineapple.



OR

QR CODE

Redirect your customer to a website, phone number or message. Create interactivity between the lighter and your message!



BL

BLACK LIGHT

Under a black light the fluor colours appear.
You can have light blue, red, green or yellow.



FA

FABRIC

Give it the look and feel of fabric with a relief effect and matt finish!



RC

RESIN CHIP

Add volume to your design!
Give the lighter a third dimension!



GR

GRANITE

Add a granular feel to the lighter!



GD

GLOW IN THE DARK

Expose the DJEEP® lighter to a light bulb or direct sunlight and observe the photoluminescent powder in dark places!



H

HOLOGRAPHIK®

A reflective silvery surface to show high quality and innovation!



PE

PEARLESCENT

Pearly and subtle shine that transmits elegance and delicacy!

BIC® GRAPHIC

BIC® WRITING INSTRUMENTS

OTHER WRITING INSTRUMENTS

NOTEBOOKS

BIC® / DJEEP® LIGHTERS AND BIC® CASES

BIC® PACKAGING

GENERAL INFORMATION

DJEEP® LIGHTERS

08D1

DJEEP® D1 LIGHTER
08D1

MOQ 10.000 units
Standard colours combination



No extra charge

Hood

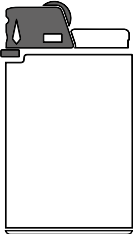

Pusher

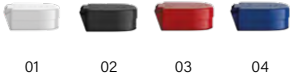
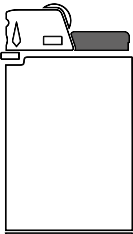

Reservoir

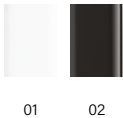

DJEEP® LIGHTERS

08D1

DJEEP® D1 LIGHTER

08D1

A DG: full-colour

MOQ 10000 units

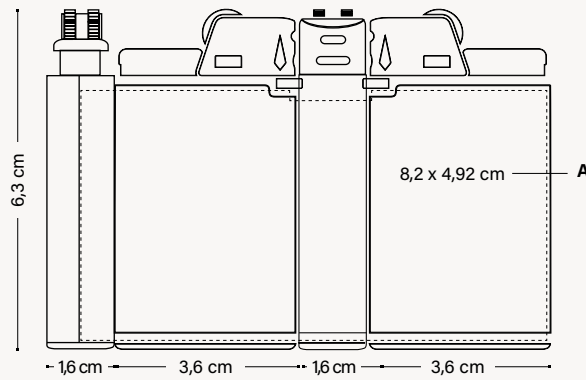

PACKAGING



STANDARD PACKAGING:
IN TRAY OF 10 UNITS

Recyclable cardboard

EXTERNAL PACKAGING



600 ± 20 KG



FSC AND
RECYCLABLE
CARDBOARD



MANUFACTURED AND
PRINTED IN DJEEP
FACTORIES



MADE IN FRANCE



REGULATORY
COMPLIANCE



UP TO 3.500



PRINTING
TECHNIQUES



DIGITAL

SUSTAINABILITY



100% ELECTRICITY
COMING FROM
RENEWABLE SOURCES



Check out
the video

See pages 272-276 for a detailed explanation of the icons.

BIC®

PACKAGING

05

BIC® PRIMARY PACKAGING

Gift boxes, pouches, and cases for personalised pens, designed to enhance every writing gift. Available in customizable packs to suit your style.

FR/

Boîtes-cadeaux, pochettes et étuis pour l'emballage personnalisé des stylos, qui mettent en valeur chaque cadeau d'écriture. Packs personnalisables disponibles pour s'adapter à votre style.

DE/

Geschenkboxen, Beutel und Etuis für personalisierte Stifte, die jedes Schreibgeschenk aufwerten. Anpassbare Sets verfügbar, passend zu Ihrem Stil.

IT/

Scatole regalo, astucci e custodie per confezioni personalizzate di penne che valorizzano ogni regalo di scrittura. Confezioni personalizzabili disponibili per adattarsi al tuo stile.

ES/

Cajas de regalo, estuches y fundas para el embalaje personalizado de bolígrafos que realzan cualquier regalo relacionado con la escritura. Packs personalizables disponibles para adaptarse a tu estilo.



BIC® PRIMARY PACKAGING FAMILY

BIC® Primary Ecolutions® Packaging

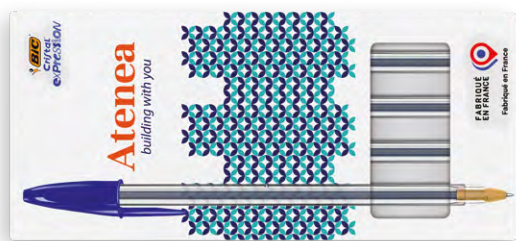

3469015464
BIC® Collection Box Slim Pens
4 units



3469013355 (For 1 item)
3469013356 (For 2 items)
3469013357 (For 3 items)
BIC® Collection Box



3469007684
BIC® Eco Sleeve



3469007685
BIC® Window Box

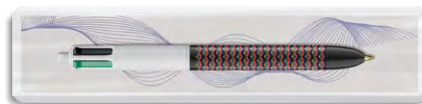

3469007686
BIC® Plastic Pouch



3469007687
BIC® Marking Set

BIC® Primary Packaging



34672000039
BIC® Black Velvet Pouch 1 item



34670000042 (For 1 item)
34670000043 (For 2 items)
34670000044 (For 3 items)
3469001173 (For 4 items)
BIC® Cello Wrap



3467000041
BIC® Frosted Pouch (For 1 or 2 items)

BIC®
GRAPHIC

BIC®
WRITING INSTRUMENTS

OTHER WRITING
INSTRUMENTS

NOTEBOOKS

BIC® / DIEEP® LIGHTERS
AND BIC® CASES

BIC®
PACKAGING

GENERAL
INFORMATION

3469015464

BIC® COLLECTION BOX SLIM PENS 4 UNITS

FSC cardboard box, customisable on each side and offering large communication surfaces. Ideal for offering our iconic BIC® products as a collection. More than a box, a great way to optimise your sales.

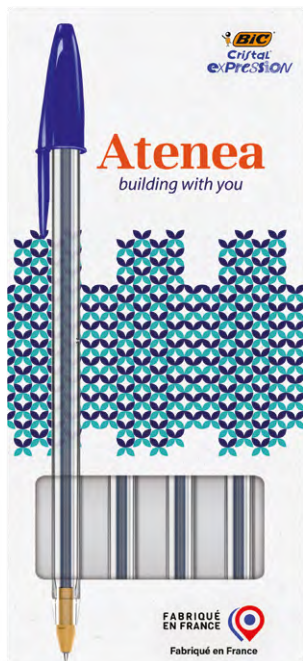

Special packaging for:



- BIC® CRISTAL® EXPRESSION**
- BIC® ROUND STIC®**
- BIC® STYLE**
- BIC® CLIC STIC**
- BIC® CRISTAL® RE'NEW™**

100% customisable from 100 units!

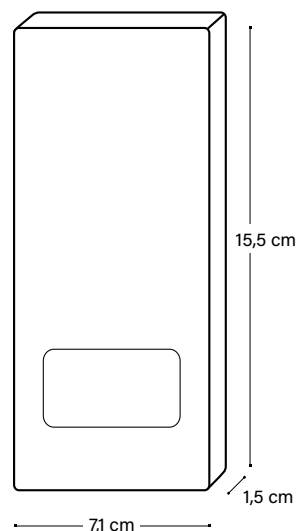

3469013355 / 3469013356 / 3469013357

BIC® COLLECTION BOX

FSC cardboard box, customisable on each side and offering large communication surfaces. Ideal for offering our iconic BIC® products as a collection. More than a box, a great way to optimise your sales.



- 3469013355 - 1 unit
- 3469013356 - 2 units
- 3469013357 - 3 units

100% customisable from 100 units!

Special packaging for:



- BIC® 4 COLOURS®**
- BIC® WIDE BODY™**
- BIC® SUPER CLIP**
- BIC® BRITE LINER® GRIP**
- BIC® GRIP ROLLER**

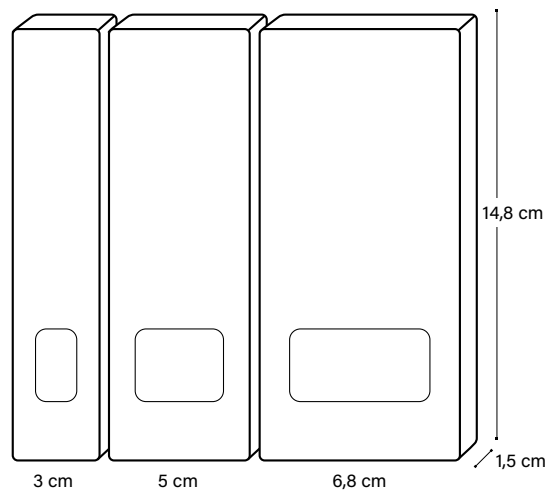
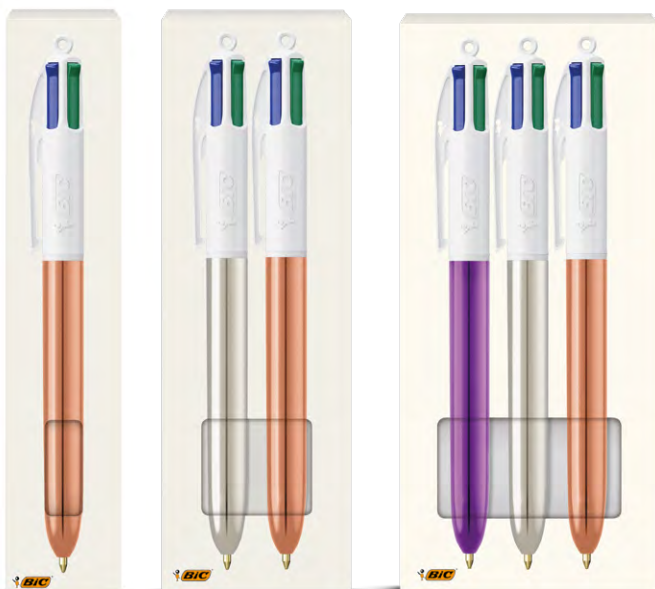

3469007684

BIC® ECO SLEEVE

Special recycled sleeve for all BIC® writing instruments except graphite pencils.

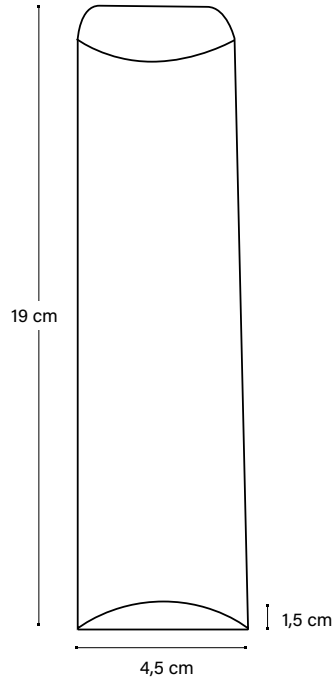

Special packaging for:



- BIC® MEDIA CLIC
- BIC® CLIC STIC
- BIC® SUPER CLIP
- BIC® WIDE BODY™
- BIC® INTENSITY® GEL CLIC



3469007685

BIC® WINDOW BOX

Premium design packaging for all BIC® writing instruments except graphite pencils.

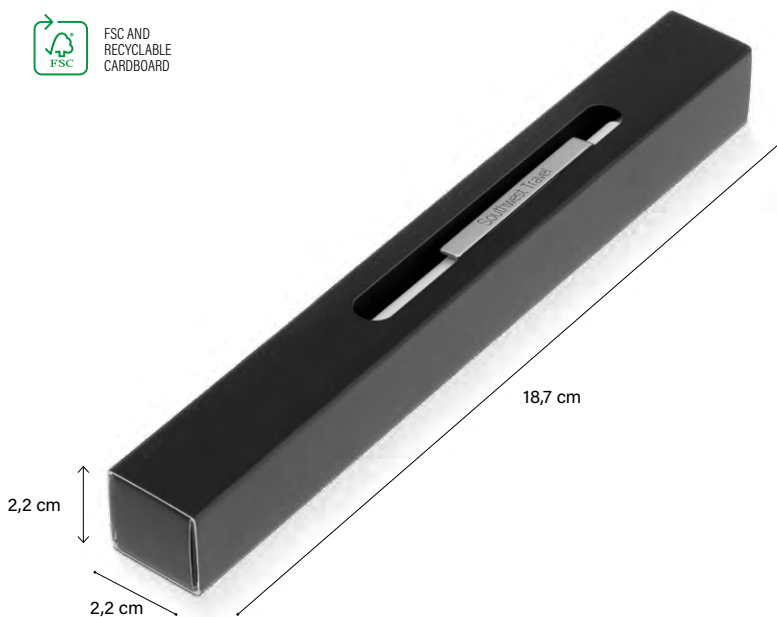

Special packaging for:



BIC® METALLIC PENS

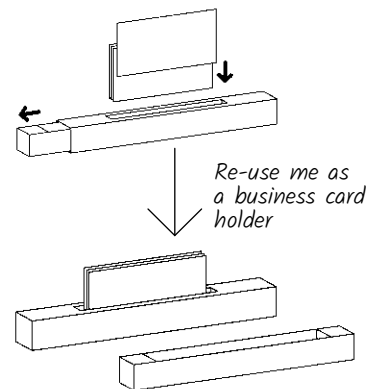

Please note: Pens shown are for display purposes only and are not included in the price.

3469007686

BIC® PLASTIC POUCH

Special design for this packaging which fits any writing instrument or 3 graphite pencils.

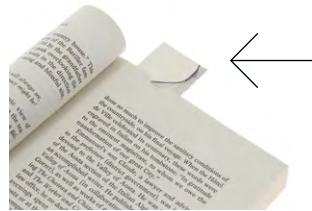

Use me as a bookmark

19,6 cm

4,6 cm

3469007687

BIC® MARKING SET

Packaging designed for all types of marker products.

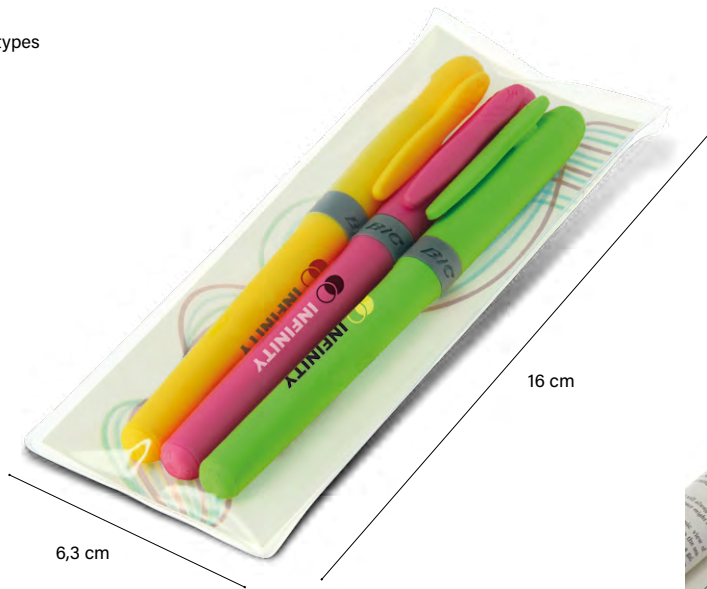

16 cm

6,3 cm

Special packaging for:



3 BIC® BRITE LINER® GRIP
3 BIC® MARK-IT



3 BIC® VELLEDA® GRIP
3 BIC® VELLEDA® FINE

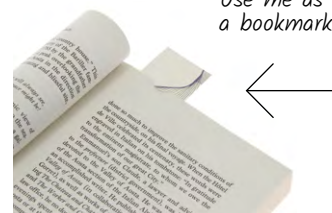

Use me as a bookmark

34670000042 / 34670000043 / 34670000044 / 3469001173

BIC® CELLO WRAP

Packaging to wrap in a tough and transparent plastic material.

- 34670000042 - 1 unit
- 34670000043 - 2 units
- 34670000044 - 3 units
- 3469001173 - 4 units



Cello wrap 1 unit



Cello wrap 2 units

BIC® PRIMARY PACKAGING

3467000041

BIC® FROSTED POUCH (FOR 1 OR 2 ITEMS)

Transparent packaging for 2 writing instruments.

A SP: max. 1 col.

Special packaging for:



- BIC® 4 COLOURS®
- BIC® MEDIA CLIC
- BIC® ROUND STIC®
- BIC® CLIC STIC
- BIC® WIDE BODY™
- BIC® SUPER CLIP
- BIC® M10® CLIC
- BIC® STYLE
- BIC® METAL PRO
- BIC® EVOLUTION® ECOLUTIONS® ERASER PENCIL
- BIC® EVOLUTION® ECOLUTIONS® CUT PENCIL
- BIC® MATIC®
- BIC® INTENSITY®
- BIC® GRIP ROLLER
- BIC® VELLEDA®
- BIC® PERMANENT MARKER ECOLUTIONS®
- BIC® MARK-IT PERMANENT MARKER
- BIC® BRITE LINER® GRIP
- BASIC PEN
- STRIPED GRIP PEN
- SLEEK STYLUS PEN
- CLICK PEN

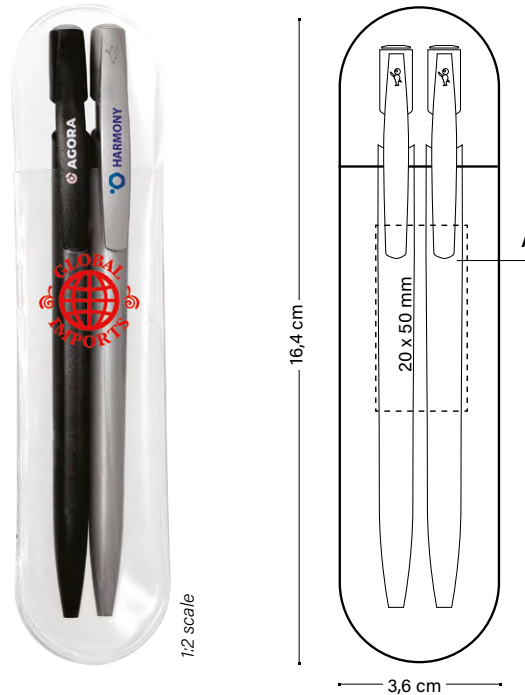

34672000039

BIC® BLACK VELVET POUCH 1 ITEM

Velvet exclusive packaging for 1 writing instrument.
Especially suitable for metal pens.

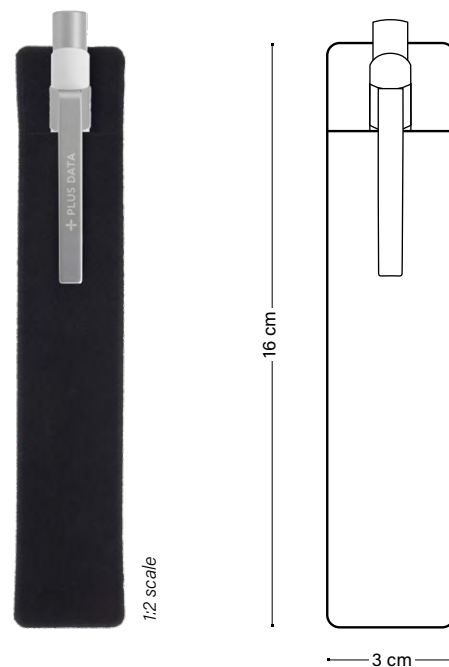

Please note: Pens shown are for display purposes only and are not included in the price.

BIC® SECONDARY PACKAGING

Practical, easy-to-handle solutions that simplify storage, handling, and transport for smoother, more efficient everyday operations.

FR/

Solutions pratiques et faciles à manipuler, simplifiant le stockage, la manutention et le transport, pour rendre les opérations quotidiennes plus fluides et efficaces pour chaque client.

DE/

Praktische, leicht zu handhabende Lösungen, die Lagerung, Handhabung und Transport vereinfachen und den täglichen Ablauf für jeden Kunden reibungsloser und effizienter gestalten.

IT/

Soluzioni pratiche e facili da gestire, che semplificano stoccaggio, movimentazione e trasporto, rendendo le operazioni quotidiane più fluide ed efficienti per ogni cliente.

ES/

Soluciones prácticas y fáciles de manejar que simplifican el almacenamiento, el manejo y el transporte, haciendo que las operaciones diarias sean más fluidas y eficientes para cada cliente.

BIC® Secondary Packaging

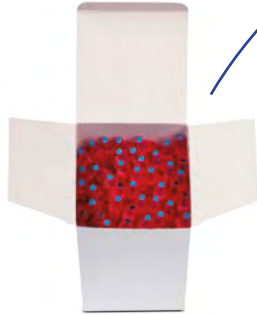

3467000009
3467000008
3467000007
Count Box



3467000013
3467000011
3467000010
Plastic Bag

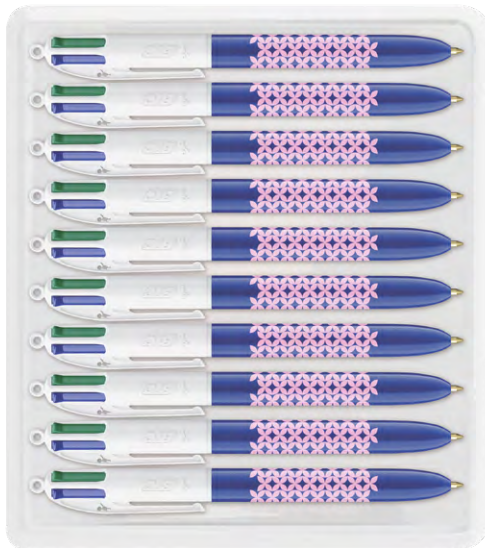

34670000080
Tray of 10 writing Instruments

BIC® SECONDARY PACKAGING

3467000009 / 3467000008 / 3467000007

COUNT BOX

3467000009 - **Small** (for 25 BIC® Clic Stic) - 6 x 6,2 x 14 cm

3467000008 - **Medium** (for 50 BIC® Media Clic or writing instruments of similar size) - 7,5 x 7,5 x 15,2 cm

3467000007 - **Large** (only for 100 BIC® Evolution® Ecolutions®) - 7,5 x 7,5 x 19 cm

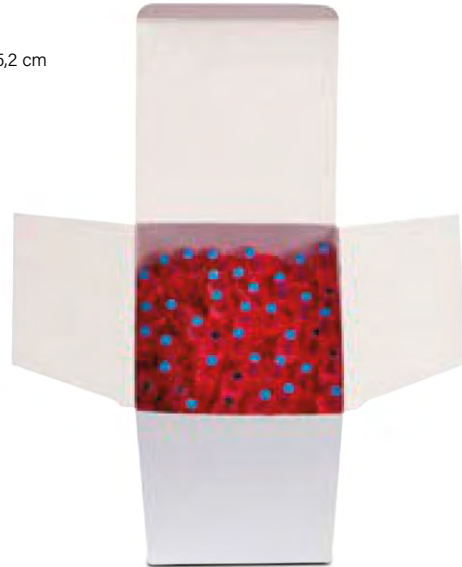

3467000013 / 3467000011 / 3467000010

PLASTIC BAG

3467000013 - **Small** (for 25 BIC® Media Clic or writing instruments of similar size) 12 x 18 cm

3467000011 - **Medium** (for 50 BIC® Media Clic or writing instruments of similar size) 15 x 22 cm

3467000010 - **Large** (for 100 BIC® Media Clic or writing instruments of similar size) 20 x 30 cm



34670000080

TRAY OF 10 WRITING
INSTRUMENTS

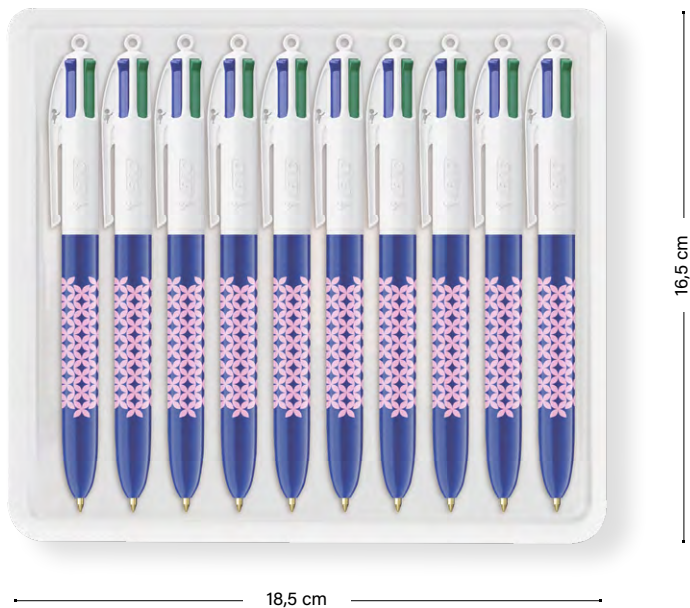

Please note: Pens shown are for display purposes only and are not included in the price.

GENERAL INFORMATION

Catalogue Overview

This section provides essential reference information for navigating the catalogue efficiently. It offers a clear and structured framework that facilitates product identification, comparison, and selection, ensuring a consistent and straightforward reading experience.

FR/

Aperçu du catalogue

Cette section fournit des informations de référence essentielles pour naviguer efficacement dans le catalogue. Elle offre un cadre clair et structuré qui facilite l'identification, la comparaison et la sélection des produits, garantissant une expérience de lecture cohérente et simple.

DE/

Katalogübersicht

Dieser Abschnitt enthält wichtige Referenzinformationen für eine effiziente Navigation im Katalog. Er bietet einen klaren und strukturierten Rahmen, der die Identifizierung, den Vergleich und die Auswahl von Produkten erleichtert und ein einheitliches und übersichtliches Leseerlebnis gewährleistet.

IT/

Panoramica del catalogo

Questa sezione fornisce informazioni di riferimento essenziali per navigare in modo efficiente nel catalogo. Offre una struttura chiara e organizzata che facilita l'identificazione, il confronto e la selezione dei prodotti, garantendo un'esperienza di lettura coerente e intuitiva.

ES/

Descripción general del catálogo

Esta sección proporciona información de referencia esencial para moverse por el catálogo de manera eficiente. Ofrece un marco claro y estructurado que facilita la identificación, comparación y selección de productos, lo que garantiza una experiencia de lectura coherente y sencilla.

Make it simple!

Symbols and abbreviations

Product index

Colour table

FILE INFORMATION

Please submit your artwork in one of the following formats:

- Electronic file with the graphic design (artwork)
- Separate file for the text. For individual laser engraving please provide texts only in Excel® format (.xls)

ARTWORKS FEATURES

Please submit your artwork in one of the following formats:

- JPG / 350 dpi not compressed (only for images, no texts)
- PDF / outlined
- Illustrator® CC / outlined
- Photoshop® CC / with layers
- ZIP files

In order to facilitate a fluid order process and obtain an appropriate final result, it is important to provide us the information in one of the above listed formats. Should the customer's design not fit into our imprint area, we will modify it accordingly.

TYPEFACES:

All the typefaces must be converted to an artwork. Verify the minimum type sizes & line weights. Please, contact Customer Service for further information.

FR

INFORMATIONS CONCERNANT LES FICHIERS

Veuillez charger votre fichier sous l'un des formats suivants:

- Un fichier électronique avec le dessin graphique
- Et un fichier différent pour le texte. Pour un marquage au laser individuel, les textes devront être fournis uniquement sous format Excel® (.xls)

PROPRIÉTÉS DU MATÉRIEL GRAPHIQUE

Envoyez-nous votre matériel graphique dans un des types de fichiers suivants :

- JPG / 350 dpi non comprimé à la taille réelle de marquage (seulement images, sans texte)
- PDF / vectorisé
- Illustrator® CC / vectorisé
- Photoshop® CC / avec les calques
- Fichiers ZIP

Il est important que vous nous fassiez parvenir les informations dans l'un de ces formats afin de traiter au mieux votre commande et d'obtenir un résultat final optimal. Si la création du client ne rentre pas dans notre format, nous la modifierons en conséquence.

TYPE DE CARACTÈRES :

Tous les types de caractères doivent être convertis en image. Vérifiez les tailles minimales des types et les épaisseurs de trait. Veuillez contacter le service clientèle pour plus d'informations.

IT

INFORMAZIONE SUI FILE:

Sempre, per quanto riguarda i file, i documenti si devono inviare come di seguito:

- un file elettronico con il design grafico (artwork)
- ed un altro file separato per il testo. Per un'incisione a laser singola, consegnare i testi esclusivamente in formato Excel® (.xls)

PROPRIETÀ DEL MATERIALE GRAFICO

Inviateci il vostro materiale grafico in uno dei seguenti tipi di file:

- JPG / 350 dpi non compresso e nel formato reale della stampa (solo per le immagini, non per il testo)
- PDF / vettoriale
- Illustrator® CC / vettoriale
- Photoshop® CC / con livelli
- file ZIP

E' importante che le informazioni vengano mandate in uno dei formati indicati al fine di sveltire l'ordine ed ottenere un miglior risultato finale. Nel caso in cui il design del cliente non si adattasse all'area di stampa, verrà adattato di conseguenza.

CARATTERI:

Tutti i caratteri devono essere convertiti in immagine. Verificare le dimensioni minime del carattere e gli spessori del tratto.

DE

ANFORDERUNGEN DRUCKUNTERLAGEN

Bitte senden Sie uns folgende Dateien:

- Reprofähige Druckvorlagen als Grafik
- Für eine Lasergravur übermitteln Sie uns bitte Ihre Druckdaten im Excel® Format (.xls)

EIGENSCHAFTEN DRUCKVORLAGEN

Technische Daten der Grafikdateien. Bitte schicken Sie Ihre Grafiken in einem dieser Formate:

- JPG / 350 dpi nicht komprimiert und in der tatsächlichen Druckgröße (nur Bilddaten, kein Text)
- PDF / Vektordatei
- Illustrator® CC / Vektordatei
- Photoshop® CC / mit Ebenen
- ZIP Format

Wir bitten um Zusendung der Daten in den angegebenen Formaten. Damit können wir den Auftrag schnellstmöglich bearbeiten und ein optimales Druckergebnis erreichen. Sofern der Entwurf des Kunden nicht in unseren Druckbereich passt, werden wir ihn entsprechend anpassen.

SCHRIFTARTEN:

Alle Schriftarten müssen in eine Vorlage umgewandelt werden. Überprüfen Sie die Mindestschriftgrößen und Linienstärken. Für weitere Informationen kontaktieren Sie bitte unseren Kundenservice.

ES

INFORMACIÓN SOBRE ARCHIVOS

En cualquier caso, los archivos deben ser dos:

- Un archivo electrónico con el diseño gráfico (creatividad) y otro archivo distinto para el texto
- Para un grabado en láser, facilita los textos únicamente en formato Excel® (.xls)

PROPIEDADES DEL MATERIAL GRÁFICO

Envíanos tu material gráfico en alguno de los siguientes tipos de archivo:

- JPG/ 350 dpi sin comprimir al tamaño real de impresión (sólo imágenes, sin texto)
- PDF / vectorizado
- Illustrator® CC / vectorizado
- Photoshop® CC / con capas
- Archivos ZIP

Es importante que nos proporciones la información en uno de estos formatos para agilizar su pedido y para obtener un resultado final adecuado. Si el diseño del cliente no encaja correctamente en el área de impresión, lo modificaremos consecuentemente.

FUENTES:

Todos los tipos de letra se deben convertir en un arte final. Verifica los tamaños de los tipos mínimos y grosos de línea. Por favor, contacta con Atención al Cliente para más información.

SPECIAL FOR WRITING PRODUCTS

SCREEN PRINTING

SÉRIGRAPHIE
SIEBDRUCK
SERIGRAFIA
SERIGRAFÍA

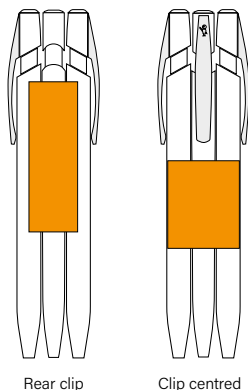

Available imprint area depends on required printing technique.

- FR La zone d'impression disponible dépend de la technique d'impression requise.
- DE Die mögliche Werbeaufdruckfläche ist von der angeforderten Drucktechnik abhängig.
- IT L'area di stampa disponibile dipende dalla tecnica desiderata.
- ES Área de impresión disponible según la técnica de impresión.



SPECIAL FOR DIGITAL LIGHTERS (J25, J23, J26 & J38)



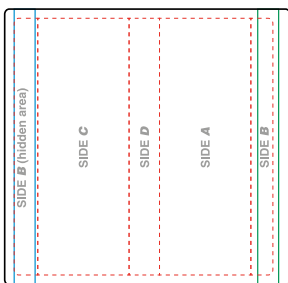







If a direct exact colour is desired a fifth colour may be chosen from the aforementioned Guide for an additional charge. For more information on achieving the closest colour match for imprints on different products within our catalogue please contact our Customer Service Department



- FR Pour toute demande de couleur directe Pantone, nous pouvons proposer une impression avec une 5ème couleur disponible dans ce catalogue, à un prix majoré. Pour plus d'informations sur la manière d'obtenir la couleur correspondante la plus proche pour des impressions sur différents produits de notre catalogue, veuillez contacter notre service client.
- DE Wenn Sie ausdrücklich eine Pantone-Farbe wünschen, können Sie zusätzlich eine fünfte Farbe aus unserem verfügbaren Repertoire auswählen. Hierfür wird ein Aufpreis berechnet. Weitere Informationen zur Farbangleichung bei Bestellung verschiedener Produkte erhalten Sie von Ihrem Kundenservice.
- IT Se si desidera un colore preciso, potrebbe essere scelto un quinto colore dalla suddetta guida a un costo aggiuntivo. Per maggiori informazioni sulla migliore corrispondenza del colore di stampa per i vari prodotti del nostro catalogo, contattare il nostro Servizio Clienti.
- ES En el caso de querer un color directo, podemos ofrecer la impresión con un 5º color de dicha Guía. Para una mejor coincidencia de colores entre los diferentes productos de nuestro catálogo, ponte en contacto con nuestro departamento de Atención al Cliente.

SYMBOLS AND ABBREVIATIONS

Printing techniques symbols

	EN	FR	DE	IT	ES
	Puffy glitter Coloured glitter texture.	Puffy glitter Texture avec paillettes colorées.	Puffy Glitter Farbige Glitzer-Textur.	Puffy glitter Texture con glitter colorati.	Puffy glitter Textura de color brillante.
	Puffy Highlighted personalisation giving a relief effect to your logo.	Puffy Une personnalisation soulignée par notre encre « Puffy », pour donner un effet de relief à votre logo.	Puffy Eine überzeugende Personalisierung mit unserer "Puffy"-Tinte, die Ihrem Logo einen Relief- Effekt verleiht.	Puffy Una personalizzazione evidenziata con il nostro inchiostro "Puffy" per dare un effetto a rilievo al tuo logo.	Puffy Resalta tu personalización dándole efecto relieve a tu logo.
	Brilliant Brilliant finish.	Brilliant Finition brillante.	Brilliant Digitaldruck mit Glanzeffekt.	Brilliant Finitura brillante.	Brilliant Acabado brillante.
	Metallic Create metallic effects on images and backgrounds.	Metallic Crée des effets métalliques sur les images ou l'arrière-plan.	Metallic Kreieren Sie Metall-Effekte mit Bildern und Hintergründen.	Metallic Crea effetti, immagini sfondi metallici. Il tuo marchio sarà inconfondibile	Metallic Crea efectos metálicos en imágenes o fondos.
	Holografic Create attractive gold or silver effects.	Holografic Crée des effets attractifs en or ou argent.	Holografic Kreieren Sie attraktive Gold- oder Silbereffekte	Holografic Trasforma il tuo logo in un immagine tridimensionale con gli ologrammi. Rende il tuo messaggio straordinario.	Holografic Convierte tu logo en una imagen tridimensional usando hologramas.
	Matt Matt finish.	Matt Finition mate.	Matt Digitaldruck mit matter Oberfläche	Matt Finitura opaca.	Matt Acabado mate.
	UV High gloss finish.	UV Finition extra brillante.	UV UV Digitaldruck mit Hochglanzeffekt.	UV Finitura lucida.	UV Acabado super brillante.
	Hot Stamping Tactile embossing	Hot Stamping Graver en relief sensible au toucher.	Hot Stamping Folien-Heißprägung	Hot Stamping Rilievo tattile	Hot Stamping Grabado en relieve sensible al tacto.
	Print 360° ballpen	Impression 360° degrés	360° Druck auf Kugelschreiber	Stampa a 360° penna a sfera	Impresión 360° en bolígrafo
	Print 360° lighter	Impression 360° degrés	360° Druck auf Feuerzeug	Stampa a 360° accendino	Impresión 360° en encendedor
	Digital. High-definition 4-colour process. 360° degrees and full length of the barrel/body.	Digital Quadrichromie haute définition. À 360° degrés et sur toute la longueur du corps.	Digital Hochauflösender Vierfarb-Prozess. 360° Rundumdruck auf dem ganzen Schaft.	Digital Alta definizione - stampa in digitale in quadricromia, 360° gradi su tutta la lunghezza del corpo.	Digital Cuatricromía de alta definición. 360° en el cuerpo entero.
	britePix™ Digital The solution for full colour communication. Now on coloured barrels!	britePix™ Digital La solution pour une communication tout en couleur. Maintenant sur des corps en couleur.	britePix™ Digital Die Lösung für farbenfrohe Kommunikation Jetzt auch auf farbigen Schäften.	britePix™ Digital La soluzione per la comunicazione a tutto colore. Ora sui fusti colorati.	britePix™ Digital La solución para una impresión a todo color. Ahora en cuerpos de colores.
	britePix™ Texture britePix™ Texture is a fresh addition to our britePix™ concept: now you don't just see the full colour – you can feel it!	britePix™ Texture britePix™ Texture apporte une nouvelle touche haut de gamme au concept britePix™. Désormais, vous pouvez non seulement voir tout en couleur, mais aussi le toucher !	britePix™ Texture britePix™ Texture ist eine neue Ergänzung für unser britePix™ Druckkonzept – man kann die Farben jetzt nicht nur sehen, man kann sie auch fühlen!	britePix™ Texture britePix™ Texture è un salto di qualità nel nostro concetto di stampa britePix™ – ora non solo puoi vedere il colore pieno, ma puoi anche toccarlo!	britePix™ Texture britePix™ Texture es un añadido premium al concepto britePix™ - ahora no sólo puedes verlo sino que ¡también puedes sentirlo!
	britePix™ personalisation Personalise each unit within the same britePix™ order.	britePix™ personalisation Personnalisez chaque unité dans une seule et même commande.	britePix™ Personalisierung Personalisieren Sie Ihre britePix™-Bestellung. Geben Sie jedem Artikel Ihrer Bestellung eine individuelle Note.	britePix™ personalisation Personalizzazione britePix™. Personalizza ogni unità dello stesso ordine britePix™.	britePix™ personalización Personalización britePix™. Personaliza cada unidad en el mismo pedido britePix™.

SYMBOLS AND ABBREVIATIONS

Printing techniques symbols



















BL Black light	FI Fragrant ink	MF Metallic Foil
BP britePix™	GT Glittering	PD Pad printing
DB Debossing	GM Glossy & matt mix	PE Pearlescent
DG Digital	GD Glow in the dark	QR QR code
ST DjEEP® soft touch®	GR Granite	RC Resin chip
3D Embossing FR - 3D embossage / ESP-Relieve 3D / GER-3D-Prägung / IT-3D Rilievo	HM Hammered metal	SP Screen printing
ET Etched	H Holographik®	TF Touch & feel
FA Fabric	LE Laser	

Ink Colours

EN	FR	DE	IT	ES	EN	FR	DE	IT	ES
● Black	Noir	Schwarz	Nero	Negro	● Light Green	Vert clair	Hellgrün	Verde chiaro	Verde claro
● Light Blue	Bleu clair	Hellblau	Azzurro	Azul claro	● Apple Green	Vert pomme	Apfelgrün	Verde	Verde Manzana
● Dark Blue	Bleu foncé	Dunkelblau	Blu	Azul oscuro	● Green Dark	Vert foncé	Dunkelgrün	Verde mela	Verde oscuro
● Red	Rouge	Rot	Rosso	Rojó	● Fluo	Fluo	Fluoreszierend	Fluo	Fluorescente
● Orange	Orange	Orange	Arancio	Naranja	● Pink	Rose	Rosa	Rosa	Rosa
● Yellow	Jaune	Gelb	Giallo	Amarillo	● Purple	Violet	Violett	Viola	Morado

SYMBOLS AND ABBREVIATIONS

Writing modes

	EN	FR	DE	IT	ES
	Ballpen M Medium 1 mm F Fine	Bille M Medium 1 mm F Fine	Kugelschreiber M Medium 1 mm F Fine	Penna a sfera M Medium 1 mm F Fine	Bolígrafo M Medium 1 mm F Fine
	Mechanical Pencil MP	Porte-mine MP	Druckbleistift MP	Portamine MP	Portaminas MP
	Pencil PC	Crayon PC	Bleistift PC	Matita PC	Lápiz PC
	Roller Ball R	Stylo à bille roulante R	Roller R	Roller R	Roller R
	Highlighter HL	Marqueur HL	Textmarker HL	Evidenziatore HL	Resaltador HL
	Stylus Pen SP	Embout caoutchouc SP	Stylus Pen SP	Stylus Pen SP	Stylus Pen SP
	Finestyle Ø 0,7mm FS	Feutre pointe fine FS Ø 0,7mm	Finestyle-Schreiber Ø 0,7mm FS	Scrittura Finestyle Ø 0,7mm FS	Escritura Finestyle FS Ø 0,7mm
	Gel G	Gel G	Gel-Schreiber G	Gel G	Gel G
	Marker MK	Marqueur pointe ogive MK	Textmarker MK	Pennarello MK	Marcador MK
	Resistant tip	Pointe résistante	Robuste Spitze	Punta resistente	Punta resistente
	No splinter	Pas d'échardes en cas de brisure	Splittert nicht	Non si scheggia	No se astilla
	Easy to use and erase	Facile à utiliser et à effacer	Leichtes Nutzen und Ausradieren	Facile da usare e da cancellare	Fácil de usar y borrar
	Smoother and darker writing	Écriture plus douce et foncée	Leichtes und farbkraftiges Schreiben	Scrittura più delicata e scura	Escritura más suave y oscura
	Smoother, more flowing writing	Écriture plus douce et fluide	Leichtes und flüssiges Schreiben	Scrittura più delicata e fluida	Escritura más suave y fluida
	Shock resistant	Résiste aux chocs	Stoßfest	Resistente agli urti	Resistente a los golpes
	Will not dry out	Ne sèche pas	Trocknet nicht aus	Non si secca	No se seca
	Protective sheath	Protecteur de mine	Minenschutz	Proteggi mina	Protector de mina
	2 leads	2 mines	2 Minen	2 mine	2 minas

Other symbols

	EN 13869 European Child Resistant Regulation for lighters.	EN 13869 Règlement Européen pour briquets avec sécurité pour enfants	EN 13869 Europäische Kindersicherheitsnorm für Feuerzeuge.	EN 13869 Normativa europea per accendini sulla sicurezza dei bambini.	EN 13869 Regulaciones Europeas para encendedores con seguridad para niños.
	ISO Certified	Certification ISO	ISO zertifiziert	Certificato ISO	Certificado ISO
	ISO International safety standards	ISO Normes internationales de sécurité	ISO Internationale Sicherheitsnormen	ISO Norme di sicurezza internazionali	ISO Normas internacionales de seguridad

SYMBOLS AND ABBREVIATIONS

Other symbols

	EN	FR	DE	IT	ES
NEW!	New	Nouveau	Neu	Nuovo	Nuevo
	Mix&Match Hundreds of colours of components in stock of writing instruments for full personalisation.	Mix&Match Des centaines de couleurs de composants en stock pour la personnalisation complète des instruments d'écriture.	Mix&Match Hunderte von Farben bei den Schreibgeräte-Komponenten auf Lager. Für eine komplette Personalisierung.	Mix&Match Centinaia di colori dei componenti di produzione degli strumenti di scrittura per una personalizzazione completa	Mix&Match Cientos de componentes de instrumentos de escritura para una completa personalización
	Custom colours Choose the exact PMS colour that suits your logo.	Couleurs personnalisées Choisissez la couleur exacte pour des décorations les mieux adaptées à votre logo.	Sonderfarben Wählen Sie genau die PMS-Farbe, die am besten zu Ihrem Logo passt.	Colori Personalizzati Scegli il colore PMS esatto che si adatta meglio al tuo logo.	Colores personalizados Elija el color exacto PMS que mejor se adapte a su logo.
	Manufactured and printed in BIC factories	Fabriqué et imprimé dans les usines BIC	In BIC-Werken hergestellt und bedruckt	Prodotto e stampato negli stabilimenti BIC	Fabricado e impreso en fábricas BIC
	Manufactured in BIC factories	Fabriqué dans les usines BIC	In BIC-Werken hergestellt	Prodotto negli stabilimenti BIC	Fabricado en fábricas BIC
	Printed in BIC factories	Imprimé dans les usines BIC	In BIC-Werken bedruckt	Stampato negli stabilimenti BIC	Impreso en fábricas BIC
	Assembled and printed in DJEEP factories	Montage et impression dans les usines DJEEP	Montage und Druck in DJEEP-Werken	Assemblaggio e stampa negli stabilimenti DJEEP	Montaje e impresión en fábricas DJEEP
	Assembled and printed in BIC factories	Montage et impression dans les usines BIC	Montage und Druck in BIC-Werken	Assemblaggio e stampa negli stabilimenti BIC	Montaje e impresión en fábricas BIC
	Quality & safety approved	Qualité et sécurité approuvées	Qualität und Sicherheit und genehmigt	Qualità e sicurezza approvata	Calidad y seguridad aprobada
	Made in Europe	Fabriqué en Europe	Hergestellt in Europa	Prodotto in Europa	Fabricado en Europa
	Made in France	Fabriqué en France	Hergestellt in Frankreich	Fabbricato in Francia	Fabricado en Francia
	Made in Spain	Fabriqué en Espagne	Hergestellt in Spanien	Prodotto in Spagna	Fabricado en España
	Viral reduction 93% in 24h	Réduction virale 93% en 24h	Reduktion von 93 % der Viren in 24 Std.	93% di riduzione virale entro 24 ore	Reducción viral 93% en 24h
	Entire pen protection	Protection sur toute la surface du stylo	Schutz der Kugelschreiberoberfläche	Protezione della superficie della penna a sfera	Protección de la superficie del bolígrafo
	Timeless protection	Protection à vie	Dauerschutz	Protezione permanente	Protección permanente
	Bacteria elimination	Protection antibactérienne	Schutz vor Bakterien	Protezione batterica	Protección contra las bacterias
	Fungal inhibition for 24h	Inhibition des champignons en 24h	Hemmt Pilzbefall 24 Std.	Inibizione di funghi 24 ore	Inhibición de hongos 24h
	Keep fingers away from the flame	Gardez les doigts loin de la flamme	Hält die Finger von der Flamme fern	Tieni le dita lontane dalla fiamma	Manten los dedos lejos de la llama
	Easily fits in the pocket	Se glisse facilement dans la poche	Passt problemlos in die Tasche	Si adatta facilmente alla tasca	Cabe fácilmente en el bolsillo
	Number of flames	Nombre d'allumages	Anzahl der Zündungen	Numero di lame	Número de encendidos

BIC GRAPHIC

BIC® WRITING INSTRUMENTS

OTHER WRITING INSTRUMENTS

NOTEBOOKS

BIC® / DJEEP® LIGHTERS AND BIC® CASES

BIC® PACKAGING

GENERAL INFORMATION







SYMBOLS AND ABBREVIATIONS



Other symbols









	EN	FR	DE	IT	ES
					
	FSC and recyclable cardboard Certification to promote the appropriate environmental management	FSC et carton recyclable Produit fabriqué avec des matériaux respectant l'environnement, utilisant des matériaux renouvelables de conifères (polymères cellulosiques).	FSC-zertifizierter und recycelbarer Karton Zertifikat zur Förderung des angemessenen Umweltmanagements	FSC e cartone riciclabile Certificazione della corretta gestione ambientale	FSC y cartón reciclable Certificación para promover la apropiada gestión ecológica
	Pharmaceutical waste	Déchets pharmaceutiques	Pharmazeutische Abfall	Rifiuti farmaceutici	Residuos farmacéuticos
	Fruit and vegetable trays	Cageots de fruits et légumes	Obst- und Gemüseverpackungen	Vassoi di frutta e verdura	Bandejas de frutas y verduras
	Fridges and yogurt pots	Réfrigérateurs et pots de yaourt	Kühlschränke und Joghurtbecher	Frigoriferi e contenitori di yogurt	Neveras y envases de yogurt
	Sugar cane	Sucre de canne	Zuckerrohr	Canna da zucchero	Caña de azúcar
	Plastic car parts	Pièces automobiles en plastique	Autoplastikteile	Parti in plastica per autoveicoli	Piezas de plástico de automóvil
	100% renewable electricity The BIC Graphic Europe factory is powered by 100% renewable energy.	100% Électricité d' énergie renouvelable L'usine BIC Graphic Europe s'alimente 100% d'électricité renouvelable.	100% Strom zu 100 % aus erneuerbaren Quellen Die Fabrik von BIC Graphic Europe bezieht ihren Strom zu 100 % aus erneuerbaren Energiequellen.	100 % elettricità da fonti rinnovabili Lo stabilimento BIC Graphic Europe funziona con elettricità proveniente 100% da fonti rinnovabili.	100% electricidad de fuentes renovables La fábrica BIC Graphic Europe funciona con energía proveniente de fuentes 100% renovables.
	Imprim'vert Certification for environmentally responsible printing practices.	Imprim'vert Certification pour des pratiques d'impression respectueuses de l'environnement.	Imprim'vert Zertifizierung für umweltfreundliche Druckpraktiken	Imprim'vert Certificazione per pratiche di stampa rispettose dell'ambiente.	Imprim'vert Certificación para prácticas de impresión respetuosas con el medio ambiente.
	Möbius Loop Product contains recycled material.	Möbius Loop Le produit contient des matériaux recyclés.	Möbius Schleife Das Produkt enthält recyceltes Material.	Möbius Loop Il prodotto contiene materiale riciclato.	Möbius Loop El producto contiene material reciclado.
	Refill Service	Service de recharge	Nachfüllservice	Servizio di ricarica	Servicio de recarga
	QR code Scan QR code	Code QR Scannez le code QR	QR Code Scannen Sie den QR Code	QR code scannerizza il QR code	QR code Escanea el código QR
	Packaging Information 250 ± 3,5 KG	Informations sur l'emballage	Information zur Verpackung	Informazioni sul packaging	Información de envasado
	DIMENSIONS: Dimensions published of each product correspond to its maximum size, regardless of the drawing position.	DIMENSIONS : Les dimensions publiées de tous les produits correspondent à la taille maximale, quelle que soit la position du dessin.	ABMESSUNGEN: Die angegebenen Abmessungen für jedes Produkt entsprechen dessen maximaler Größe. Unabhängig von der Druckposition auf der Abbildung.	DIMENSIONI: Le dimensioni pubblicate relative a ciascun prodotto corrispondono alla sua dimensione massima indipendentemente dalla posizione del disegno.	DIMENSIONES: Las dimensiones publicadas en cada producto corresponden a su tamaño máximo, independientemente de la posición que muestre el dibujo.
	Regulatory compliance	Respectant les normes	Einhaltung gesetzlicher Bestimmungen	Conformità normativa	Cumplimiento de la normativa

SYMBOLS AND ABBREVIATIONS

Technical Parameters for each Type of Printing

	DIGITAL / DIGITAL TRANSFER	
Minimum positive text	4 pt (1.4 mm)	4 Point text
Minimum negative text	7 pt (2.4 mm)	7 Point text
Minimum text for half tone	1.5 pt (0.5 mm)	7 Point text
Minimum thickness for positive lines	0.25 pt (0.08 mm)	
Minimum thickness for negative lines	0.5 pt (0.17 mm)	
Minimum thickness for lines in half tone	0.5 pt (0.17 mm)	
Minimum half tone values	C: 8% / M: 8% / Y: 12% / K: 8%    	

	britePix™	
Minimum positive text	6 pt (2.1 mm)	6 Point text
Minimum negative text	7 pt (2.4 mm)	7 Point text
Minimum thickness for positive lines	0.4 pt (0.14 mm)	
Minimum thickness for negative lines	0.5 pt (0.17 mm)	
Minimum thickness for half tones	1 pt (0.35 mm)	
Percentage half tone		

	SCREEN PRINTING/ PAD PRINTING		HOT STAMPING / DEBOSSING		LASER ENGRAVING	
Minimum positive text	6 pt (2.1 mm)	6 Point text	10 pt (3.5 mm)	10 Point text	6 pt (2.1 mm)	6 Point text
Minimum negative text	9 pt (3.1 mm)	9 Point text	15 pt (5.25 mm)	15 Point	NOT RECOMENDED	
Minimum thickness for positive lines	0.4 pt (0.14 mm)		1.5 pt (0.5 mm)		0.3 pt (0.1 mm)	
Minimum thickness for negative lines	0,5 pt (0.176 mm)		2 pt (0.706 mm)		0.5 pt (0.17 mm)	
Minimum thickness for half tones	1.5 pt (0.5 mm)		NOT POSSIBLE		NOT POSSIBLE	
Percentage half tone	50%					

PRODUCT INDEX

BIC® WRITING INSTRUMENTS

BIC® Cristal® Expression _____	38
BIC® Cristal® Re'New™ _____	40
BIC® Cristal® Re'New™ Black _____	42
BIC® Style _____	44
BIC® Round Stic® _____	48
BIC® Round Stic® Ecolutions® _____	51
BIC® M10® Clic _____	54
BIC® Media Clic _____	60
BIC® Media Clic Advance _____	58
BIC® Media Clic Ecolutions® _____	61
BIC® Media Clic Ecolutions® Plus _____	62
BIC® Media Clic Grip _____	65
BIC® Media Clic Grip Ecolutions® _____	66
BIC® Media Clic BGuard™ antibacterial _____	70
BIC® Media Clic BGuard™ antimicrobial Ecolutions® _____	72
BIC® Media Clic Biobased Ecolutions® _____	74
BIC® Media Clic Biobased BGuard™ antibacterial _____	76
BIC® Media Clic Shine _____	78
BIC® Media Clic Glacé _____	80
BIC® Clic Stic _____	82
BIC® Clic Stic Ecolutions® _____	83
BIC® Clic Stic Softfeel® _____	85
BIC® Clic Stic Stylus _____	86
BIC® Clic Stic Stylus Ecolutions® _____	86
BIC® Super Clip _____	92
BIC® Super Clip Ecolutions® _____	93
BIC® Super Clip Advance _____	96
BIC® Super Clip Glacé _____	96
BIC® Super Clip Glacé Advance _____	100
BIC® Super Clip Soft _____	102
BIC® Super Clip Soft Advance _____	103
BIC® Super Clip Origin _____	104
BIC® Wide Body™ _____	108
BIC® Wide Body™ Ecolutions® _____	109
BIC® Wide Body™ Mini Digital _____	110
BIC® 4 Colours® _____	116
BIC® 4 Colours® ECO _____	118
BIC® 4 Colours® Rainbow Decor _____	120
BIC® 4 Colours® Bicolor _____	122
BIC® 4 Colours® Gradient _____	124
BIC® 4 Colours® Pastel _____	126
BIC® 4 Colours® Fashion _____	128
BIC® 4 Colours® Sun _____	130
BIC® 4 Colours® Fine _____	132
BIC® 4 Colours® Fluo _____	134
BIC® 4 Colours® Glacé _____	136
BIC® 4 Colours® Shine _____	138
BIC® 4 Colours® Soft _____	140
BIC® 4 Colours® Wood Style _____	142
BIC® 4 Colours® Flags Collection _____	144
BIC® 4 Colours® 3+1 ^{HB} _____	146
BIC® Metal Pro _____	148

BIC® Grip Roller _____	154
BIC® Intensity® Gel Clic _____	156
BIC® Brite Liner® Grip _____	160
BIC® Highlighter Flat _____	162
BIC® Velleda® White Board Marker Fine _____	164
BIC® Velleda® White Board Marker Grip _____	165
BIC® Mark-It Permanent Marker _____	165
BIC® Permanent Marker Ecolutions® _____	167
BIC® Matic® _____	170
BIC® Media Clic Mechanical pencil _____	172
BIC® Media Clic Grip Mechanical pencil _____	173
BIC® Media Clic Grip Ecolutions® Mechanical pencil _____	173
BIC® Evolution® Ecolutions® _____	178
BIC® Kids Evolution® Colouring Set _____	182
Sprout™ Graphite pencil _____	184

OTHER WRITING INSTRUMENTS

Basic Pen _____	190
Click Pen _____	192
Striped Grip Pen _____	194
Sleek Stylus Pen _____	198

BIC® PARTNER

BIC® Partner Hard Cover _____	204
BIC® Partner Flex Cover _____	206
BIC® Partner FruitCover _____	208
BIC® Partner Notebooks Tailormade Service _____	210

BIC® LIGHTERS AND CASES

BIC® J25 Lighter _____	218
BIC® J23 Lighter _____	222
BIC® J26 Lighter _____	226
BIC® J38 Lighter _____	230
BIC® EZ Reach™ Lighter _____	234
BIC® Styl'it Luxury Case _____	238
BIC® Aluminium Flat Case _____	240
BIC® Clip Case _____	241
BIC® 3D Case _____	242
BIC® Pocket Ashtray _____	244

DJEEP® LIGHTERS

DJEEP® D1 Lighter _____	248
-------------------------	-----

BIC® PACKAGING

BIC® Primary Packaging Ecolutions® _____	258
BIC® Primary Packaging _____	258
BIC® Secondary Packaging Ecolutions® _____	264

COLOUR TABLE

 01 White	 1E White recycled	 57 Opaque white	 3C White pearl	 01BIO BIO white	 1T White polished	 51 Transparent	 69 Frosted white	 2E Frosted white recycled		
 8D Yellow pastel	 8G Light yellow	 12 Yellow	 12W Yellow wood	 63 Frosted yellow	 6AW Natural wood	 012BIO BIO yellow	 4D Clear yellow	 6F Light brown	 60 Natural	
 9C Inspiring autumn	 26 Gold	 76 Gold glacé	 1G Acid orange	 10 Orange	 90 Orange pastel	 71 Frosted orange	 92 Clear orange	 10B Orange warm		
 03 Red	 03G Red glacé	 03F Red soft	 8E Red recycled	 87 Clear red	 03BIO BIO red	 66 Frosted red	 08 Burgundy			
 14A Peaceful Pink	 14 Pink	 5C Pink fizz	 1P Acid pink	 014G Pink glacé	 07 Gold Pink	 11 Pink	 80 Pink	 97 Rose Gold	 98 Magenta	
 84 Purple pastel	 13 Violet	 39 Frosted Dark Purple	 7G Metallic purple	 2D Purple	 93 Clear Purple	 4B Frosted Purple	 2M Metallic Dark Purple			
 8C Lime	 68 Frosted green	 6C Grass green	 88 Clear light green	 59 Apple green	 82 Frosted dark green	 72 Clear green	 5G Light green	 05G Green glacé	 05 Metallic green	
 05 Green	 05W Green wood	 20 Dark green	 7E Dark green recycled	 88 Clear dark green	 05BIO BIO green	 3B Frosted jungle				
 83 Blue pastel	 4M Cozy blue	 3D Caribbean blue	 86 Clear blue	 67 Frosted blue	 24 Light blue	 04BIO BIO blue	 04 Blue	 04G Blue glacé	 40 Frosted dark blue	 4R Blue turquoise
 34 Metallic Blue	 89 Clear dark blue	 7C Metallic navy blue	 25 Dark blue	 07 Navy blue	 07F Navy blue soft	 10E Navy blue recycled				
 35 Chrome	 47 Silver	 47G Silver glacé	 75 Metallic silver	 18 Metal	 06 Grey	 27 Dark grey	 8H Clear dark grey	 6W Warm Grey		
 02BIO BIO black	 02W Black wood	 02F Black soft	 02 Black	 3E Black recycled	 2N Black matt					

The colours shown above are for reference only. Actual colour may vary slightly depending on the product.

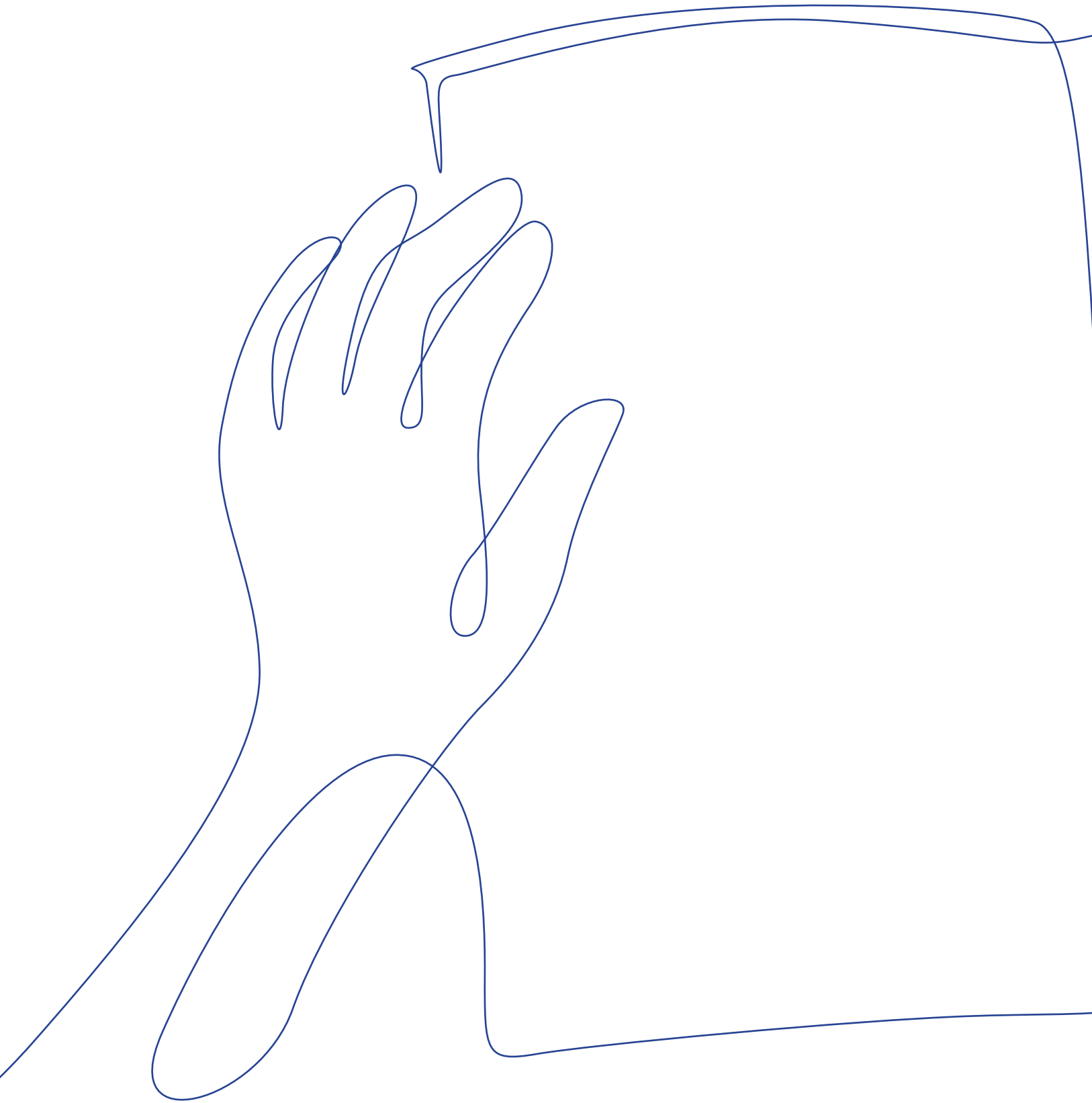

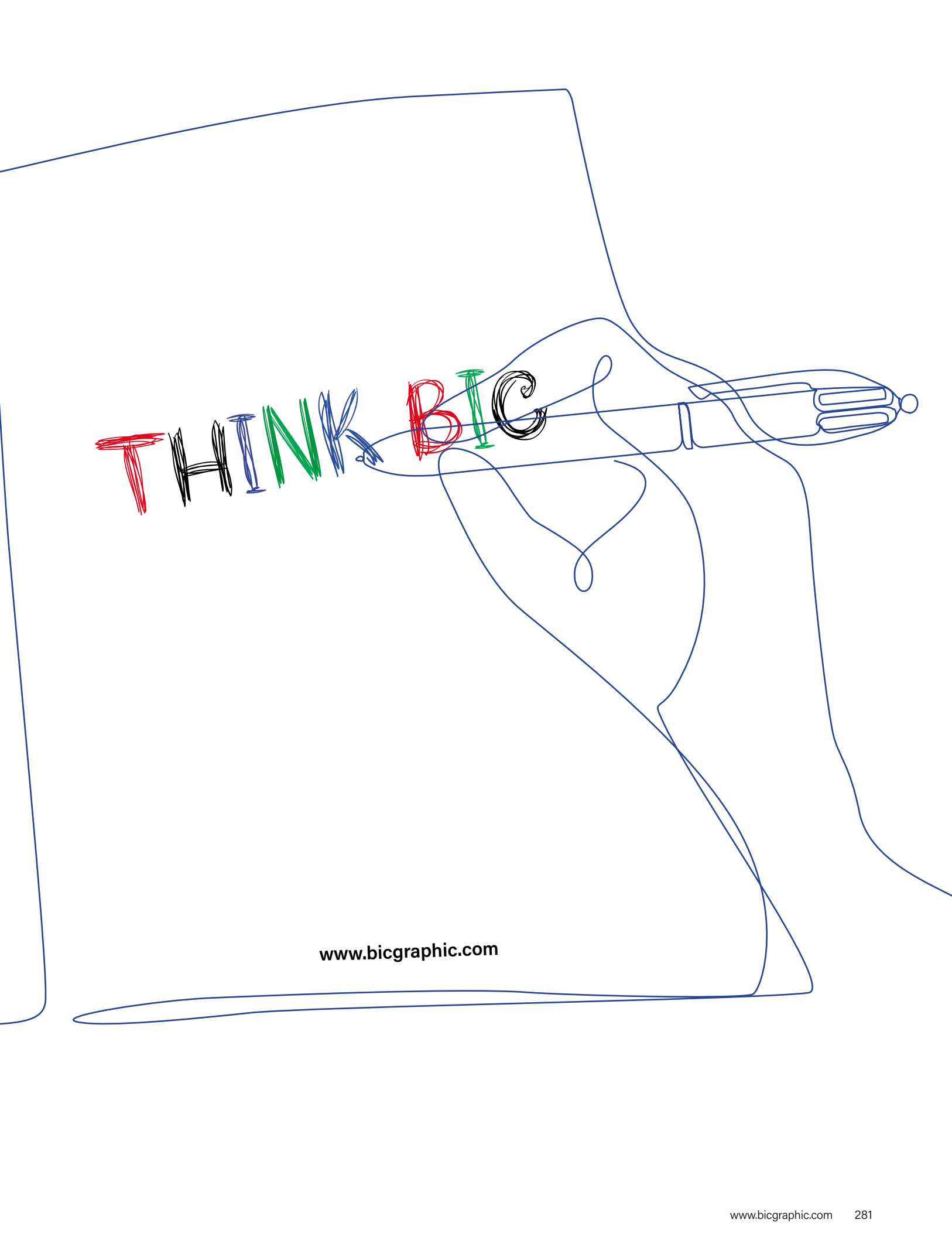

THINK BIG

www.bicgraphic.com





www.bicgraphic.com

Via E. Ferrari, 16 | 25030 Roncadelle (BS)
info@blitz26.it
blitzgroup.it

